

bralco

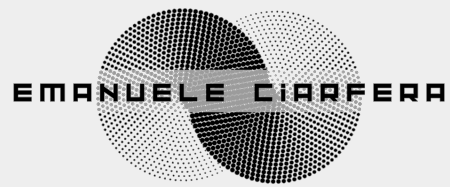

ar

k

ki

 **bralco**

Index

armadi ABA • cabinets ABA • armoires ABA •
Schränke ABA • ABA-kasten • armarios ABA

5-24

credenze • storage units • desserte •
Beistellmöbel • dressoirs • aparador

25-38

armadi ASL • cabinets ASL • armoires ASL •
Schränke ASL • ASL-kasten • armarios ASL

39-52

sistema Ubi • Ubi system • système Ubi •
Ubi-System • Ubi-systeem • sistema Ubi

53-76

sistema Concerto • Concerto system • système Concerto •
Concerto-System • Concerto-systeem • sistema Concerto

77-96

cassettiere e mobili di servizio • pedestals and service side units •
caissons et éléments de service • Container und Multifunktionscontainer •
ladenkasten en servicemeubels • cajoneras y módulos de servicio

97-124

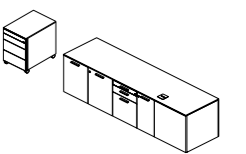
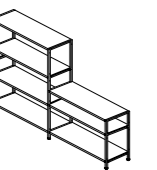
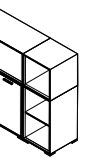
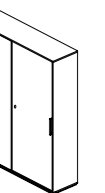
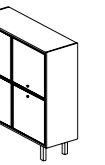
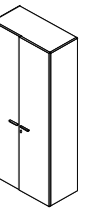

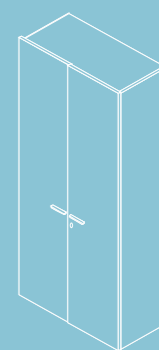

ABA





moduli e dimensioni • modules and dimensions •
 modules et dimensions • Module und Abmessungen •
 modules en afmetingen • módulos y dimensiones



d: 46 cm
d: 18"

d: 36 cm
d: 14"

* w: 80 cm, NO d:36 cm
 * w: 31 1/2", NO d:14"

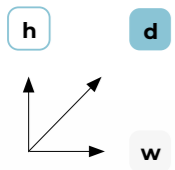

h: 270,6 cm
h: 106 1/2"

h: 232,2 cm
h: 91 1/2"

h: 193,8 cm
h: 76 1/4"

h: 155,4 cm
h: 61"

h: 117 cm
h: 46"

h: 78,6 cm
h: 31"





riloga appendiabiti
pull-out coat hanger
portemanteaux extractible
Ausziehbare Kleiderstange
kleerhangerrail
percha extraíble



barra di rinforzo per ripiano fisso e mobile in melaminico
reinforced bar for fixed and movable melamine shelf
barre de renforcement pour étagère en mélamine fixe et mobile
Verstärkung für feste und mobile Fachboden aus Melamin
verstevigingsbalk voor vast en mobiele melamine schap
barra de refuerzo para estante fijo y móvil de melamina

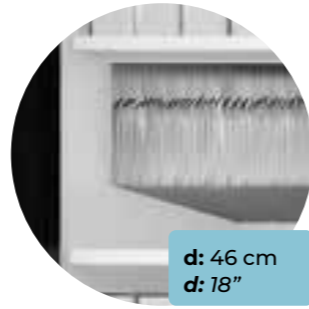

d: 46 cm
d: 18"

ripiano metallico porta cartelle
metallic shelf file holders
étagère en métal porte DS
Metallboden mit Mappenaufhängung
metalen schap voor mappen
estante metalico para carpetas



d: 46 cm
d: 18"

fondo per telaio estraibile
bottom for files frame
fond pour cadre extractible
Bodenplatte für Hängeauszug
bodem voor uitneembaar frame
fondo para extraíble

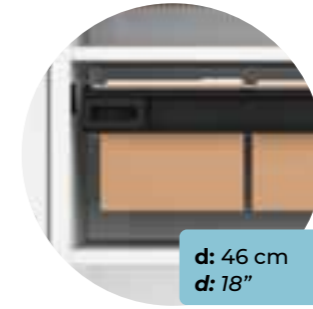

d: 46 cm
d: 18"

telaio estraibile porta cartelle (consultare il listino)
pull-out frame for folders (see price list)
porte-dossiers extractibles (voir la liste des prix)
Hängeauszug Rahmen für Ordner (siehe Preisliste)
uitneembaar frame voor mappen (zie prijslijst)
soporte extraíble para carpetas (ver lista de precios)



barra porta cartelle su ripiano melaminico
metal Files bar for melamine shelf
barre porte DS pour étagère en mélamine
Mappen-Aufhängeschiene auf Melaminboden
balk voor mappen op een melamine schap
barra para carpetas bajo estante en melamina

h: 270,6 cm
h: 106 1/2"

h: 232,2 cm
h: 91 1/2"

h: 193,8 cm
h: 76 1/4"

h: 155,4 cm
h: 61"

h: 117 cm
h: 46"

h: 78,6 cm
h: 31"



32 mm
1 1/4"

w: 50 cm
w: 19 3/4"

w: 80-100 cm
w: 31 1/2"-39 1/4"

w: 50 cm
w: 19 3/4"

w: 80-100 cm
w: 31 1/2"-39 1/4"

w: 50 cm
w: 19 3/4"

w: 80-100 cm
w: 31 1/2"-39 1/4"

w: 50 cm
w: 19 3/4"

w: 80-100 cm
w: 31 1/2"-39 1/4"

w: 50 cm
w: 19 3/4"

w: 80-100 cm
w: 31 1/2"-39 1/4"

w: 50 cm
w: 19 3/4"

w: 80-100 cm
w: 31 1/2"-39 1/4"

w: 80-100 cm
w: 31 1/2"-39 1/4"

fianco armadio, fianco armadio,
fianco armadio, fianco armadio,
fianco armadio, fianco armadio,

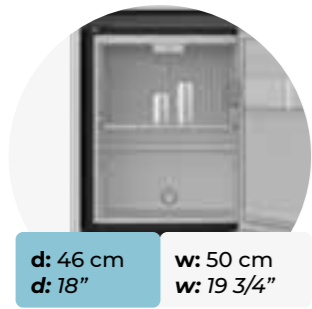

d: 46 cm
d: 18" w: 50 cm
w: 19 3/4"

frigorifero da incasso - 30 l
built-in refrigerator - 30 l
réfrigérateur encastrable - 30 l
Eingebauter Kühlschrank - 30 l
ingebouwde koelkast - 30 l
nevera empotrable - 30 l



porta rifiuti
trashcan
corbeille à papier
Papierkorb
afvalmand
papelera



schiena di finitura (18 mm, 0 3/4")
finishing back panel (18 mm, 0 3/4")
dos de finition (18 mm, 0 3/4")
Sichrückwand (18 mm, 0 3/4")
afwerking achterkant (18 mm, 0 3/4")
trasera de acabado (18 mm, 0 3/4")

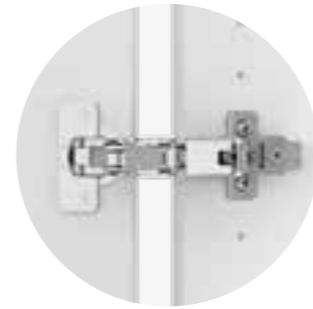

cerniera 170° (no ante vetro)
170° opening hinges (not for glass doors)
ouverture charnières 170° (pas pour portes vitrées)
Scharnier mit 170°-Öffnung (nicht für Glastüren)
scharnier 170° (zonder glazen deuren)
apertura bisagras 170° (no para puertas de vidrio)

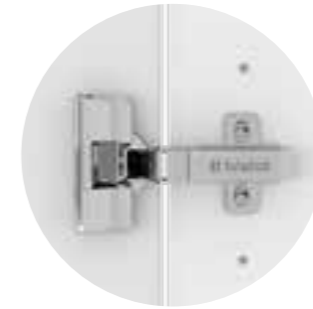

kit slow-motion per cerniera 110° (no per ante legno)
slow-motion kit for 110° hinge (no for wooden doors)
kit slow-motion pour charnière 110° (pas pour portes en bois)
Anschlagdämpfer für Scharnier mit 110°-Öffnung (nicht für Holztüren)
slow-motion per scharnier 110° (niet voor hout deuren)
slow-motion para bisagra 110° (no para puerta en madera)



cerniera 110° slow-motion per ante legno
110° slow-motion hinge for wooden doors
Charnière slow-motion 110° pour portes en bois
110° Zeitlupenband für Holztüren
110° slow-motion scharnier voor houten deuren
bisagra 110° slow-motion para puerta en madera

ABA lockers

h: 193,8 cm
h: 76 1/4"

h: 155,4 cm
h: 61"

h: 117 cm
h: 46"

h: 78,6 cm
h: 31"

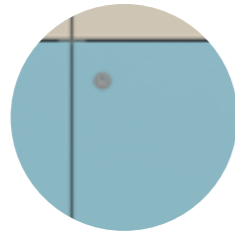
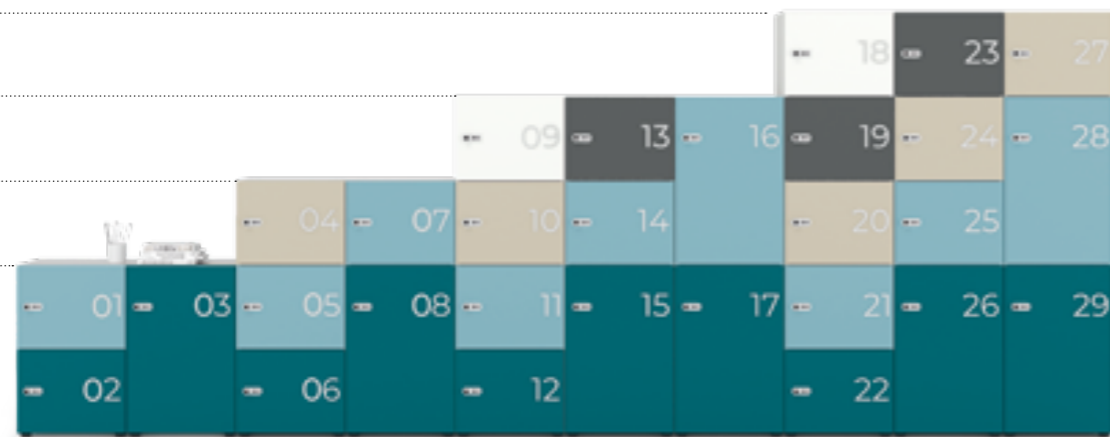

chiusura con serratura
key locking system
fermeture avec serrure
Schließung mit Schloss
sluising met slot
cerrada con cerradura



chiusura con combinazione
combination locking system
fermeture avec combinaison
Schließung mit Kombination
sluising met combinatie
cerradura con combinacion

massima fruibilità • maximum usability • facilité d'utilisation •
maximale Ausnutzung • maximale bruikbaarheid • maxima facilidad de uso

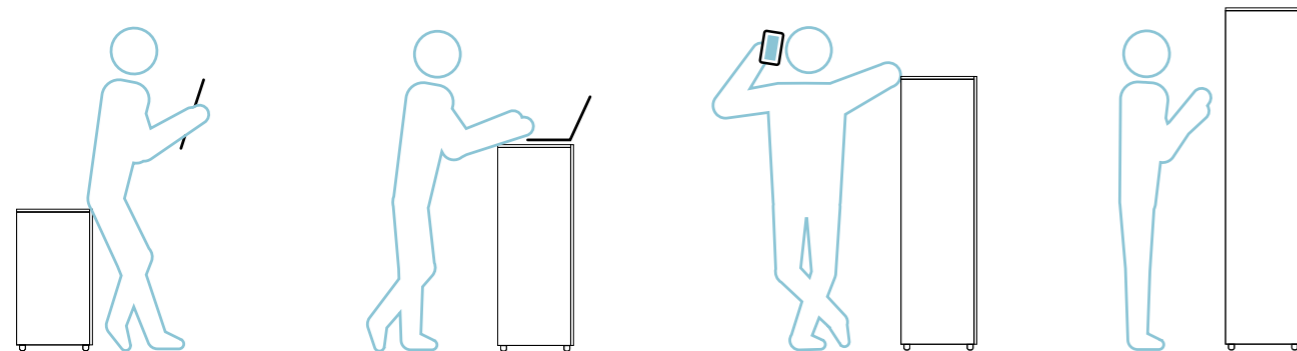

componenti e finiture • composants and finishes •
composants et finitions • Bauteile und Oberflächen •
componenten en afwerkingen • componentes y acabados

top e fianchi di finitura, top and sides, top et flanc de finition,
Abdeckplatte + Seitenverkleidungen, boven en zijpanelen,
tapa-costado de cierre en madera

1

legno, wood, bois,
Holzfurnier, hout, madera

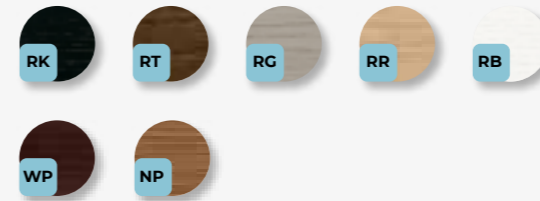

melaminico, melamine (laminated), mélamine,
melamin, melamine, melamina



laccato opaco, matt lacquered, lacqué mat,
matt lackiert, mat gelakt, laqueado mate

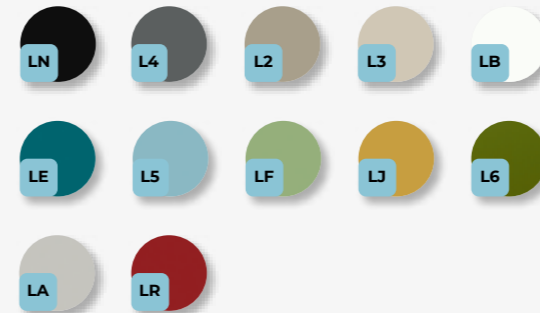

scozza e ripiani, structure and shelves, structure et étagères,
Korpus und Einlegeböden, omhulsel en schappen, estructura
y estantes

2

melaminico, melamine (laminated), mélamine,
melamin, melamine, melamina



metallo (solo ripiani D:46, D:18), metal (only for shelves d:46cm,
d:18"), métal (seulement pour étagères p:46cm, p:18"), Metall (nur
für Regale T:46cm, T:18"), metaal (alleen voor schappen d:46cm,
d:18"), metal (solo para estantes p:46cm, p:18")

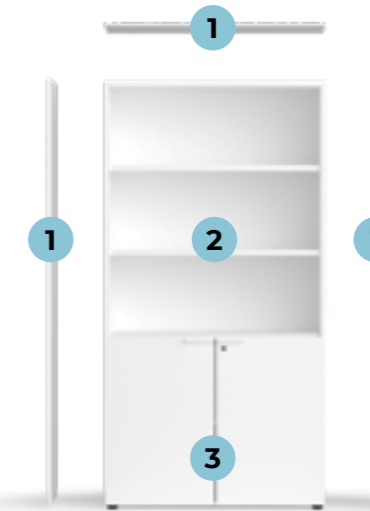

top: obbligatorio fino ad H.155,4 cm - 61"
top: compulsory up to h.155,4cm - 61"
top: obligatoire jusqu'à h.155,4cm - 61"
Abdeckplatte: obligatorisch bis zur Höhe 155,4 cm - 61"
bovenpaneel: verplicht tot h.155,4cm - 61"
tapa: obligatoria hasta h.155,4cm - 61"



top-fianco in melaminico o laccato
melamine (Laminated) or lacquered top-closing side
top-flanc de finition en mélamine ou laqué mat
Abdeckplatte+Seitenverkleidungen aus Melamin od.matt lackiert
bovenpaneel-zijpaneel in melamine of gelakt
tapa-costado de cierre en melamina o laqueado mate

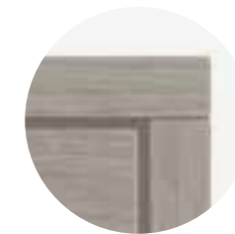

top-fianco in legno
wood top-closing side
top-flanc de finition en bois
Abdeckplatte+Seitenverkleidungen furniert
bovenpaneel-zijpaneel in hout
tapa-costado de cierre en madera

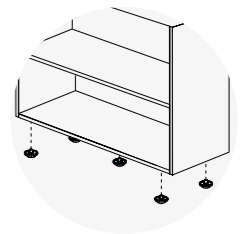

5° piedino antiflessione standard
no-bending standard 5th foot
5° vérin anti-flexion standard
Standard Fünfter Verstärkungsfuss
5de anti-flex poot standaard
5° pie que no flexiona estándar

ante senza telaio • doors without frame • portes sans châssis
Türen ohne Rahmen • deuren zonder frame • puertas sin bastidor

legno, wood, bois,
Holz furnier, hout, maderá

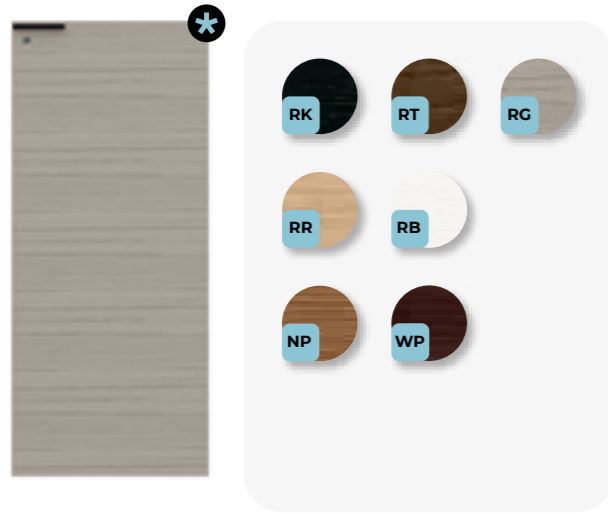

melaminico, melamine (lamine), mélamine,
melamin, melamine, melamina

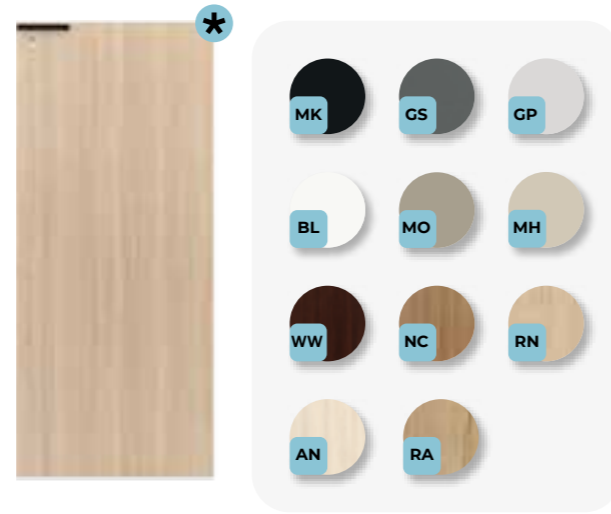

laccato opaco, matt lacquered, lacqué mat,
matt lackiert, mat gelakt, laqueado mate

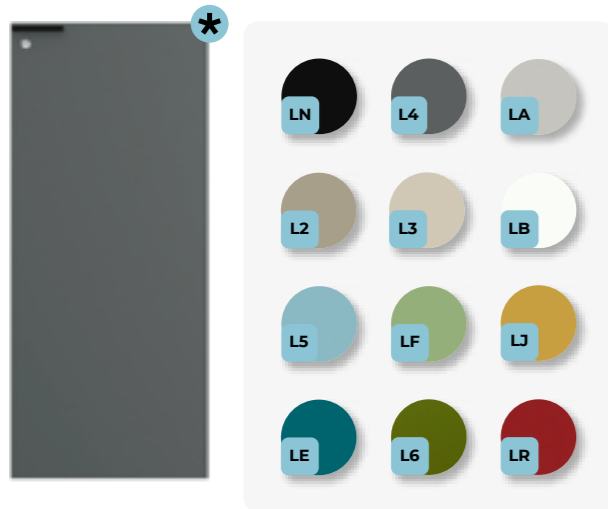

maniglie, handles, poignées,
Griffe, handgrepen, tiradores

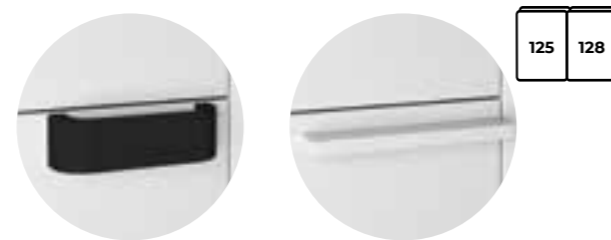

vetro senza telaio, glass door without frame, porte en verre sans châssis,
Rahmenlose Glastür, glazen deur zonder frame, puerta de vidrio sin bastidor



serratura per ante vetro
lock for glass door
serrure pour porte en verre
Schloss für Glastür
slot voor glazen deur
cerradura puerta de vidrio

ante con telaio • doors with frame • portes avec châssis
Türen mit Rahmen • deuren met frame • puertas con bastidor

vetro con telaio base, glass door with standard frame, porte en verre avec châssis base,
Glastür mit Standardrahmen, basisframe glazen deur, puerta de vidrio con bastidor base

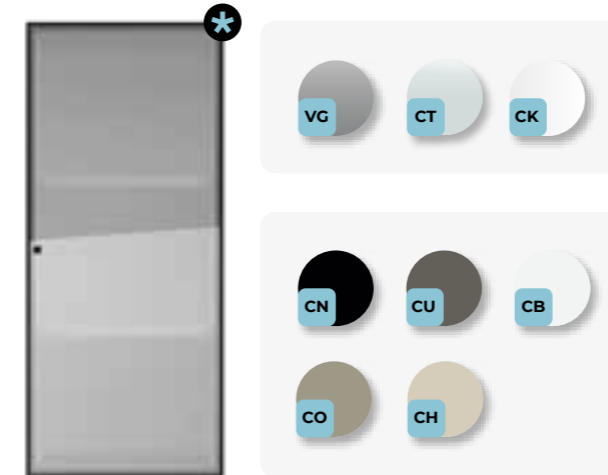

finiture telaio, frame finish, finitions
châssis, Rahmenoberflächen,
afwerking frame, acabados bastidor

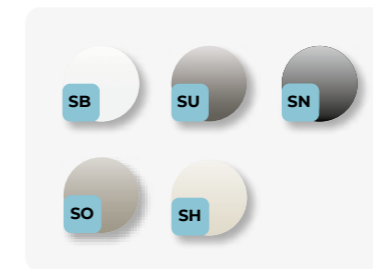
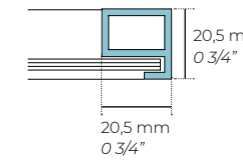

pomolo ante vetro
knob for glass door
pommeau pour porte en verre
Griff für Glastür
knop voor glazen deur
tirador puerta de vidrio

vetro con telaio cromato, glass door with chromed frame, porte en verre avec châssis chromé,
Glastür mit Chromrahmen, glazen deur met verchromd frame, puerta de vidrio con marco cromado

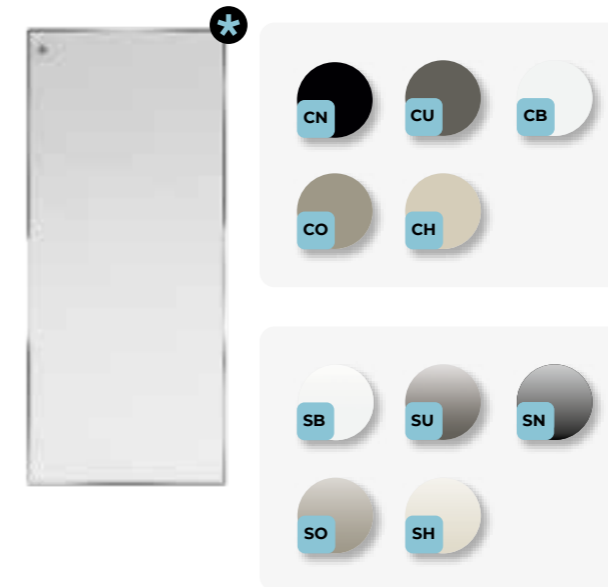

finiture telaio, frame finish, finitions
châssis, Rahmenoberflächen,
afwerking frame, acabados bastidor

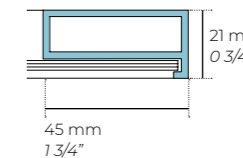

pomolo ante vetro
knob for glass door
Pommeau pour porte en verre
Griff für Glastür
knop voor glazen deur
tirador puerta de vidrio

cerniere soft optional, optional soft-closing hinge, charnière
avec fermeture ralentie en option, Optionale Scharniere mit
Anschlagsdämpfer, optionele scharnieren soft, bisagra soft opcional

cerniera soft di serie, standard soft-closing hinge, charnière
avec fermeture ralentie de série, Serienmäßige Scharniere mit
Anschlagsdämpfer, standaard scharnieren soft, bisagra soft de serie

numerosa combinazioni di finiture • numerous finishes combinations •
 nombreuses combinaisons de finitions • Zahlreiche Kombinationen von Oberflächen •
 talrijke combinaties van afwerkingen • muchas combinaciones de acabados

numero finiture, number of finishes, numéro de finitions,
 Anzahl Oberflächen, aantal afwerkingen, numero de acabados

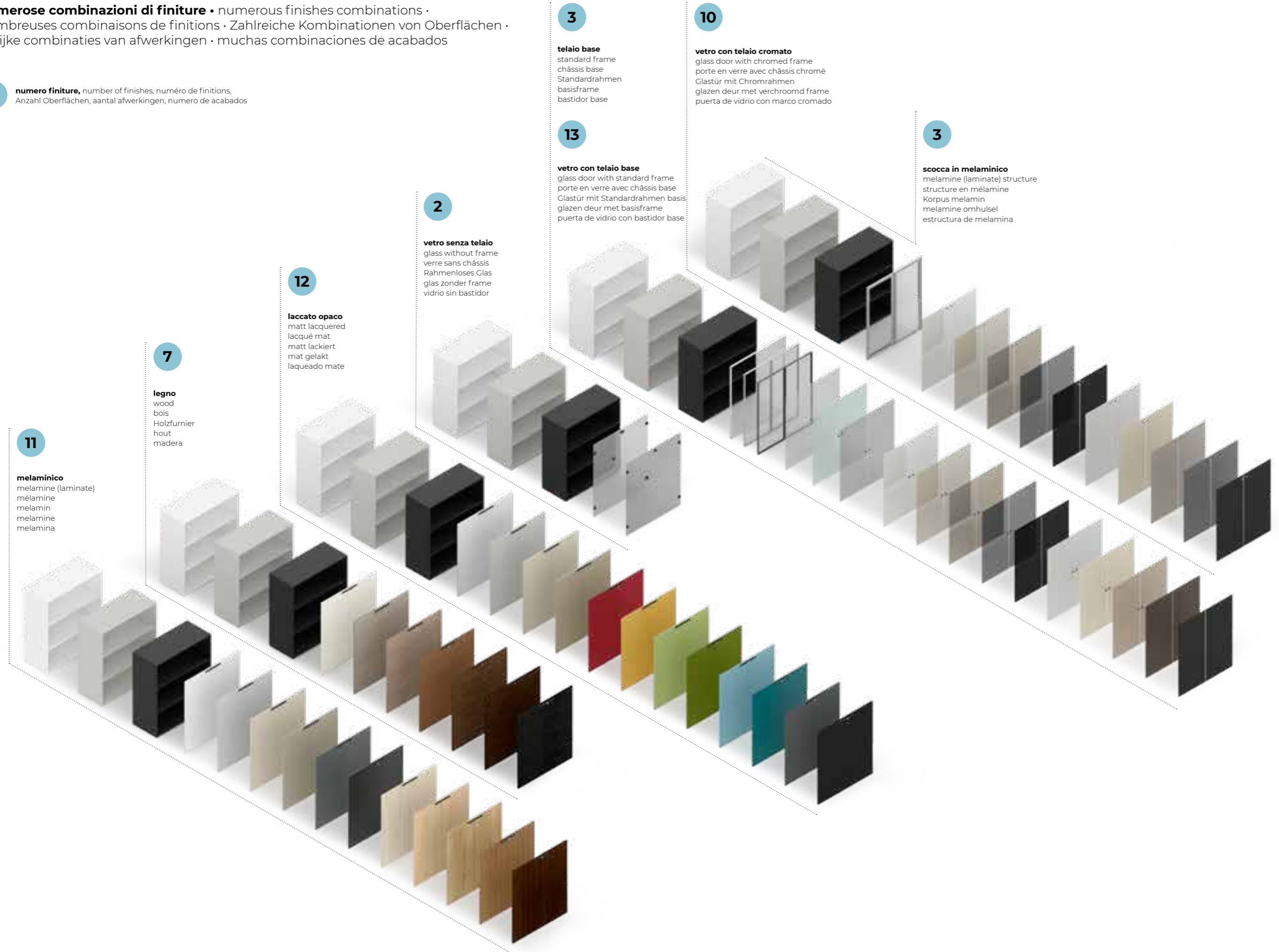

3

telaio base
 standard frame
 châssis base
 Standardrahmen
 basisframe
 bastidor base

10

vetro con telaio cromato
 glass door with chromed frame
 porte en verre avec châssis chromé
 Glastür mit Chromrahmen
 glazen deur met verchromd frame
 puerta de vidrio con marco cromado

13

vetro con telaio base
 glass door with standard frame
 porte en verre avec châssis base
 Glastür mit Standardrahmen basis
 glazen deur met basisframe
 puerta de vidrio con bastidor base

3

scocca in melaminico
 melamine (laminated) structure
 structure en mélamine
 Korpus melamin
 melamine omhulsel
 estructura de melamina

2

vetro senza telaio
 glass without frame
 verre sans châssis
 Rahmenloses Glas
 glas zonder frame
 vidrio sin bastidor

12

laccato opaco
 matt lacquered
 lacqué mat
 matt lackiert
 mat gelakt
 laqueado mate

7

legno
 wood
 bois
 Holzfurnier
 hout
 maderá

11

melaminico
 melamine (laminated)
 mélamine
 melamin
 melamine
 melamina





serratura con nottolino estraibile
lock with removable cam
serrure avec barillet extractible
Abnehmbarer Schlosszylinder
slot met uitneembare pal
cerradura con trinchete extraíble



coppia chiavi pieghevoli
pair of foldable keys
paire de clés pliantes
Paar faltbare Schlüssel
paar vouwbare sleutels
par de llaves plegables



anta con parapolvere montato
door with duster
porte avec cache-poussière intégré
Tür mit Abdichtleiste
deur met gemonteerde stofkap
puerta con goma para bloquear el polvo



ripiano con reggiripiano
shelf with support
étagère avec support
Fachboden mit Halterungen
schap met schappensteun
estante con soportes

25 mm
1"



schiena strutturale da 10 mm, 0 1/4"
structural back panel 10 mm, 0 1/4" thick
dos structurel ép. 10 mm, 0 1/4"
10 mm, 0 1/4" starke Rückwand
structurele achterkant van 10 mm, 0 1/4"
traseira estructural de 10 mm, 0 1/4"



pedino livellatore
levelling foot
vérin de compensation
Niveausgleichsfuss
stelpoot
pie nivelador

18 mm
0 3/4"

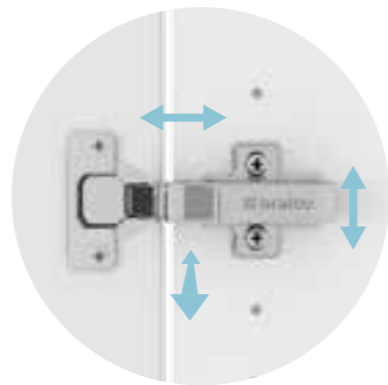

anta con cerniera regolabile montata
door with levelling hinge
porte avec charnière réglable montée
Tür mit montiertem einstellbarem Scharnier
deur met gemonteerde, verstelbaar scharnier
puerta con bisagra regulable montada

forms

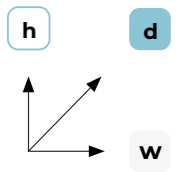

d: 36-46 cm
d: 14" - 18"

w: 50 cm,
w: 19 3/4"

w: 80 - 100 cm
w: 31 1/2" - 39 1/4"

h: 78,6 cm
h: 31"

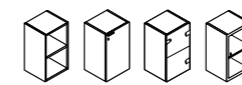

Lockers

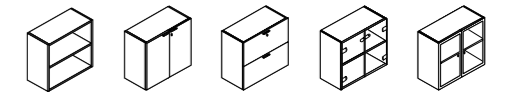
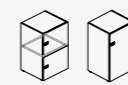

h: 117 cm
h: 46"

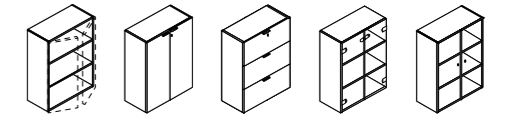
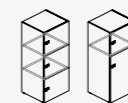
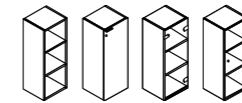

h: 155,4 cm
h: 61"

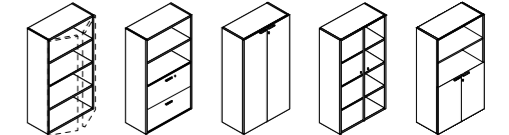
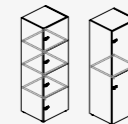
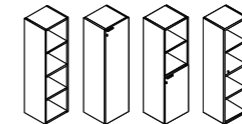

h: 193,8 cm
h: 76 1/4"

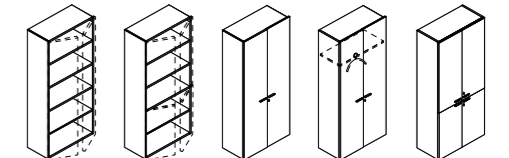
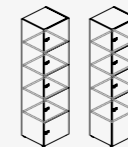
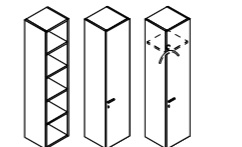

h: 76,8 cm
h: 30 1/4"

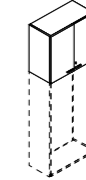
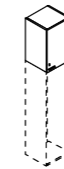

h: 232,2 cm
h: 91 1/2"

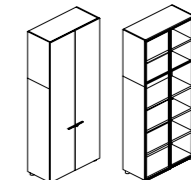
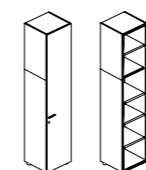

w: 80 cm - NO d: 36 cm
w: 31 1/2" - NO d: 14"
*NO d: 36 cm
*NO d: 14"

coppia fianchi di chiusura, pair of fastening sides, paire flancs de finition,
Paar Seitenverkleidungen, paar afsluitende zijpanelen, par de costados de cierre

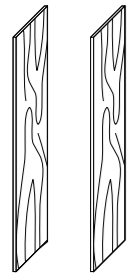

top*, top*, top*, Abdeckplatte*,
bovenpaneel*, Tapa*

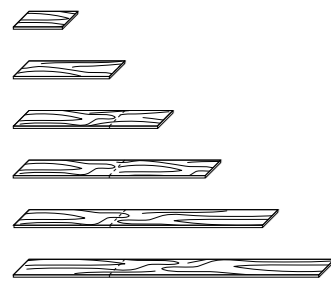

a - melaminico/ laccato opaco, melamine (Laminate)/matt lacquered,
mélamine/laqué mat, Melamin/matt lackiert, melamine/mat gelakt
melamina/laqueado mate

b - legno, wood, bois,
Holzfurnier, hout, madera

	w	h	d
a.	1,2 cm, 0 1/2"	78,1÷270,1 cm 30 3/4"÷106 1/4"	36-46 cm 14"-18"
b.	1,3 cm, 0 1/2"	76,8÷192 cm 30 1/4"÷75 1/2"	46 cm 18"

	w	h	d
a.	50÷300 cm, 19 3/4"÷118"	1,2 cm, 0 1/2"	36-46 cm 14"-18"
b.	52,7÷302,7 cm, 20 3/4"÷119"	1,3 cm, 0 1/2"	1,3 cm, 0 1/2"

***obbligatorio per armadi fino ad h 155,4 cm - 61"**

*compulsory for bookcases up to h.155,4 cm - 61"

*obligatoire pour les armoires jusqu'à h.155,4 cm - 61 "

*obligatorisch für Schränke bis zur Höhe 155,4 cm - 61"

*verplicht voor kasten tot h.155,4 cm - 61"

*obligatorio para armarios hasta h.155,4 cm - 61"

connessione top-fianco, top-side connector, connection top-flanc,
Verbindung Abdeckplatte-Seite, verbinding bovenpaneel-zijpaneel, conexion tapa-costado

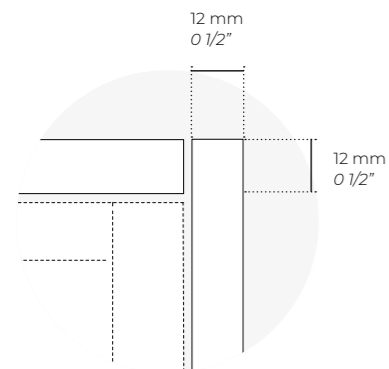

a* - dx

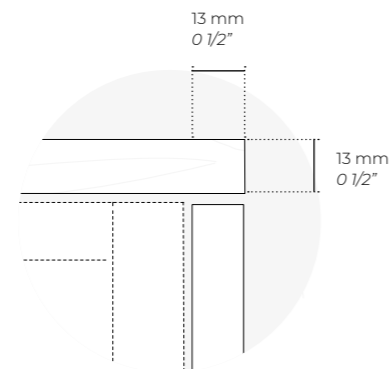

b - dx**

***in presenza del fianco: top obbligatorio**, *with side fastener: top is compulsory,
*en présence du flanc: top obligatoire, *Bei Seitenverkleidungen: Abdeckplatte obligatorisch,
*bij aanwezigheid zijpaneel: bovenpaneel verplicht, *con costados: tapa obligatoria

****in presenza del top: fianco obbligatorio**, **with top: Side fastener is compulsory,
**en présence du top: flanc obligatoire, **Bei Abdeckplatte: Seitenverkleidungen obligatorisch,
**bij aanwezigheid bovenpaneel: zijpaneel verplicht **con tapa: costados obligatorios

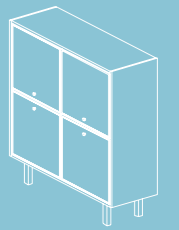

credenze
storage units
desserte
Beistellmöbel
dressoirs
aparador





moduli e dimensioni • modules and dimensions •
 modules et dimensions • Module und Abmessungen •
 modules en afmetingen • módulos y dimensiones



d: 46 cm
d: 18"

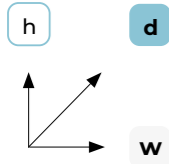

a.
h: 122,9 cm
h: 48 1/4"

b.
h: 123 cm
h: 48 1/2"

a.
h: 71,7 cm
h: 28 1/4"

b.
h: 71,8 cm
h: 28 1/4"



a.
melaminico/ laccato opaco, melamine (Laminato)/matt lacquered, mélamine/laqué mat, Melamin/matt lackiert, melamine/mat gelakt, melamina/laqueado mate

b.
legno, wood, bois, Holzfurnier, hout, madera

a.
w: 102,4 cm,
w: 40 1/4"

b.
w: 102,7 cm,
w: 40 1/2"

a.
w: 102,4 cm,
w: 40 1/4"

b.
w: 102,7 cm,
w: 40 1/2"

a.
w: 202,4 cm,
w: 79 3/4"

b.
w: 202,7 cm,
w: 79 3/4"

a.
w: 102,4 cm,
w: 40 1/4"

b.
w: 102,7 cm,
w: 40 1/2"

a.
w: 102,4 cm,
w: 40 1/4"

b.
w: 102,7 cm,
w: 40 1/2"

a.
w: 202,4 cm,
w: 79 3/4"

b.
w: 202,7 cm,
w: 79 3/4"

componenti e finiture • composants and finishes •
composants et finitions • Bauteile und Oberflächen •
componenten en afwerkingen • componentes y acabados

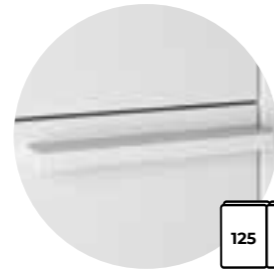

pomolo per ante vetro con telaio cromato
knob for glass door with chromed frame
pommeau pour porte en verre avec châssis chromé
Griff für Glastür mit Chromrahmen
knop voor glazen deur met verchromd frame
tirador para puerta de vidrio con marco cromado

pomolo per ante vetro con telaio base
knob for glass door with standard frame
pommeau pour porte en verre avec châssis base
Griff für Glastür mit Standardrahmen basis
knop voor glazen deur met basisframe
tirador puerta de vidrio con bastidor base

maniglie
handles
poignées
Griffe
handgrepen
tiradores

maniglie
handles
poignées
Griffe
handgrepen
tiradores

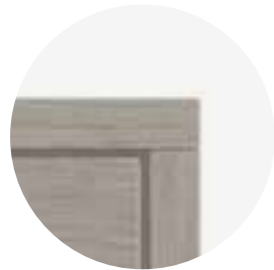

top-fianco in legno;
wood top-closing side;
top-flanc de finition en bois;
Abdeckplatte+Seitenverkleidungen
furniert;
bovenpaneel-zijpaneel in hout;
tapa-costado de cierre en madera

top-fianco in melaminico o laccato;
melamine (Laminate) or lacquered
top-closing side;
top-flanc de finition en mélamine ou laqué mat;
Abdeckplatte+Seitenverkleidungen
aus Melamin od.matt lackiert;
bovenpaneel-zijpaneel in melamine of gelakt;
tapa-costado de cierre
en melamina o laqueado mate

piedino, foot, vérin de compensation,
Füßchen, poot, pie

plastica, plastic, plastique,
Plastik, kunststof, plastica



base, base, base,
Basis, basis, base

melaminico, melamine (laminate), mélamine,
melamin, melamine, melamina



top-fianchi, top and sides, top et flanc,
Abdeckplatte + Seitenverkleidungen, boven en zijpanelen,
tapa-Costado de cierre

Legno, wood, bois,
Holz furnier, hout, madera

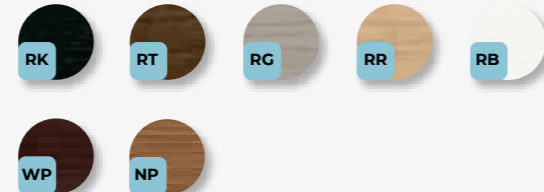

melaminico, melamine (laminate), mélamine,
melamin, melamine, melamina



ante • doors • portes • Türen • deuren • puertas

legno, wood, bois,
Holz furnier, hout, madera



melaminico, melamine (laminate), mélamine,
melamin, melamine, melamina



laccato opaco, matt lacquered, lacqué mat,
matt lackiert, mat gelakt, laqueado mate



vetro, glass doors, verre,
Glas, glas, vidrio

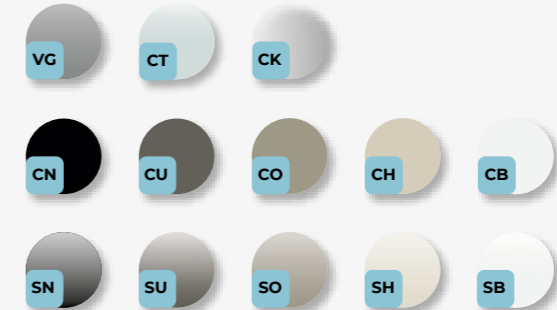
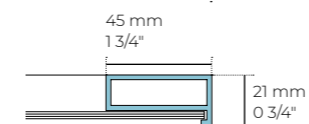
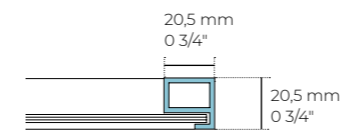

finiture telaio, frame finish, finitions châssis,
Rahmenoberflächen, afwerking frame, acabados bastidor

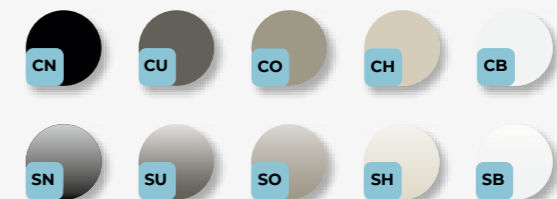

finiture telaio, frame finish, finitions châssis,
Rahmenoberflächen, afwerking frame, acabados bastidor



numerosa combinazioni di finiture • numerous finishes combinations •
 nombreuses combinaisons de finitions • Zahlreiche Kombinationen von Oberflächen •
 talrijke combinaties van afwerkingen • muchas combinaciones de acabados

numero finiture, number of finishes, numéro de finitions,
 Anzahl Oberflächen, aantal afwerkingen, numero de acabados

3

telaio base
 standard frame
 châssis base
 Standardrahmen
 basisframe
 bastidor base

10

vetro con telaio cromato
 glass door with chromed frame
 porte en verre avec châssis chromé
 Glastür mit Chromrahmen
 glazen deur met verchromd frame
 puerta de vidrio con marco cromado

1

scocca in melaminico
 melamine (laminated) structure
 structure en mélamine
 Korpus melamin
 melamine omhulsel
 estructura de melamina

13

vetro con telaio base
 glass door with standard frame
 porte en verre avec châssis base
 Glastür mit Standardrahmen basis
 glazen deur met basisframe
 puerta de vidrio con bastidor base

12

laccato opaco
 matt lacquered
 lacqué mat
 matt lackiert
 mat gelakt
 laqueado mate

10

melaminico
 melamine (laminated)
 mélamine
 melamin
 melamine
 melamina

7

legno
 wood
 bois
 Holzfurnier
 hout
 madera

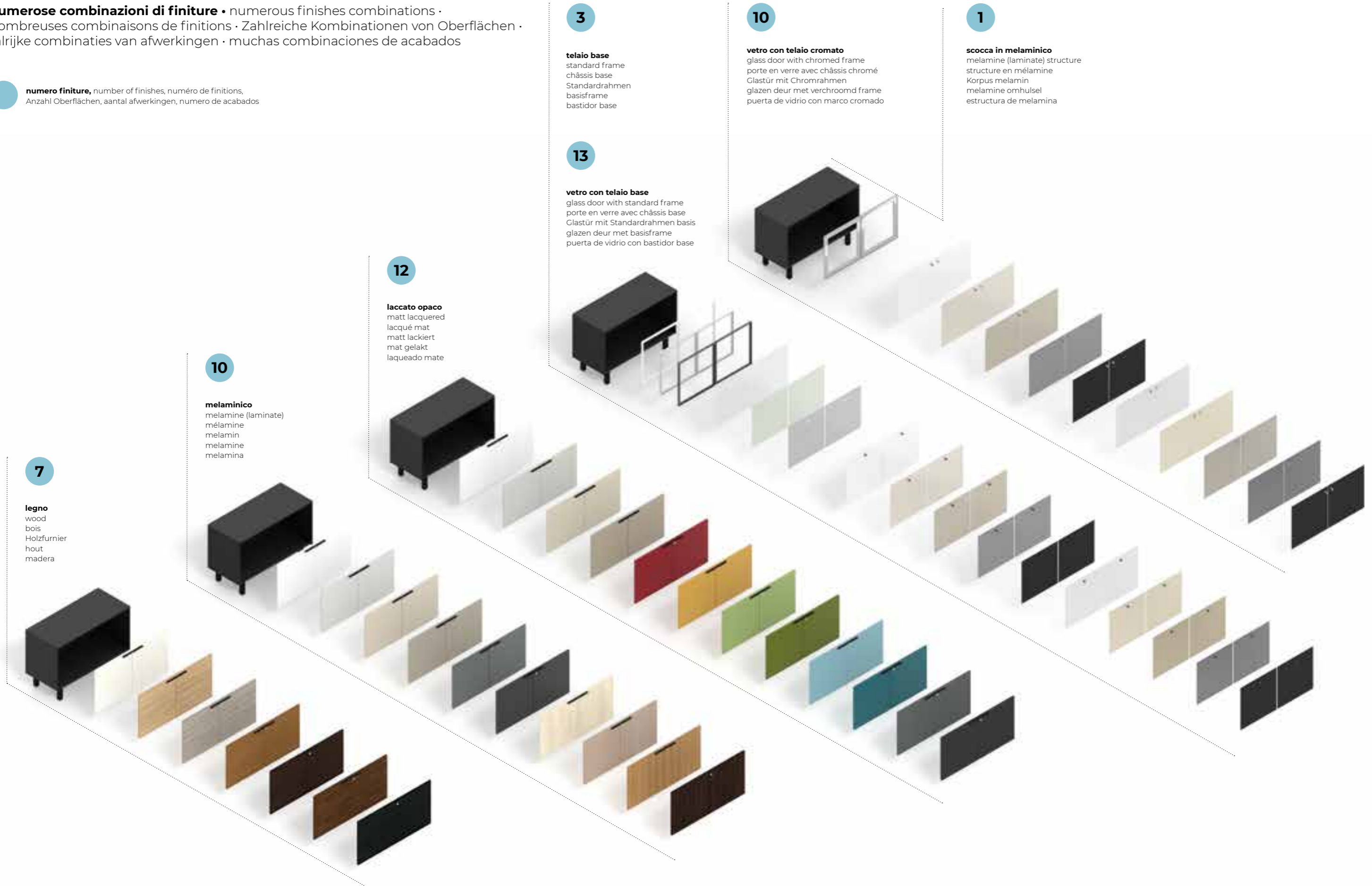

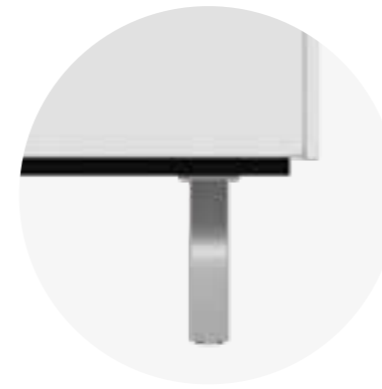

piedino
foot
vérin de compensation
Füßchen
poot
pie

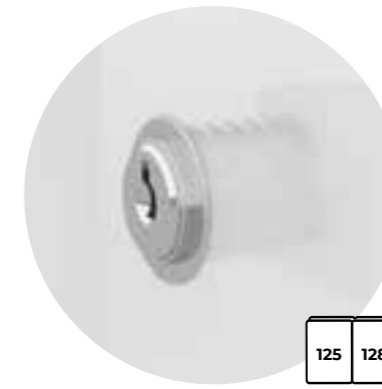

serratura con nottolino estraibile
lock with removable cam
serrure avec barillet extractible
Abnehmbarer Schlosszylinder
slot met uitneembare pal
cerradura con trinchete extraíble

125 128

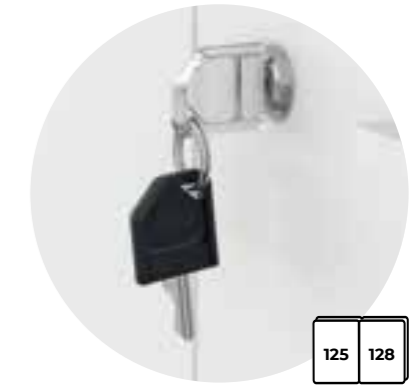

coppia chiavi pieghevoli
pair of foldable keys
paire de clés pliantes
Paar faltbare Schlüssel
paar vouwbare sleutels
par de llaves plegables

125 128



fondo antiflessione 18 mm
no-bending base
base anti-flexion
Starrer Boden
anti-flex bodem
fondo anti flexion



schiena strutturale da 10 mm, 0 1/4"
structural back panel 10 mm, 0 1/4" thick
dos structurel ép. 10 mm, 0 1/4"
10 mm, 0 1/4" starke Rückwand
structurele achterkant van 10 mm, 0 1/4"
trasera estructural de 10 mm, 0 1/4"



ripiano con reggiriipiano
shelf with support
étagère avec support
Fachboden mit Halterungen
schap met schappensteun
estante con soportes

25 mm
1"



anta con parapolvere montato
door with duster
porte avec cache-poussière intégré
Tür mit Abdichtleiste
deur met gemonteerde stofkap
puerta con goma para bloquear el polvo

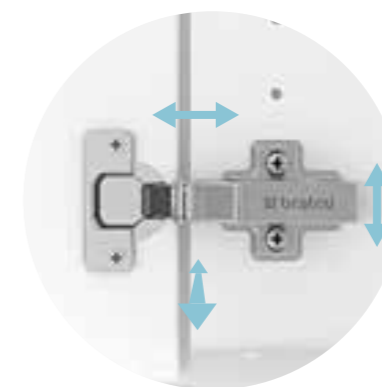

anta con cerniera regolabile montata
door with levelling hinge
porte avec charnière réglable montée
Tür mit montiertem einstellbarem Scharnier
deur met gemonteerde, verstelbaar scharnier
puerta con bisagra regulable montada

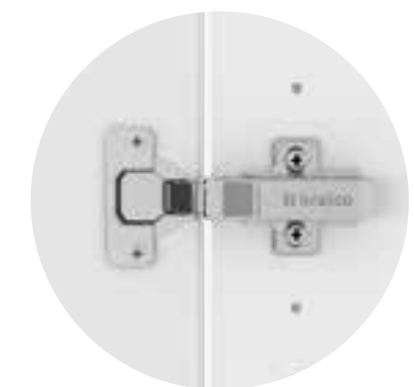

cerniera 110° slow-motion per ante legno
110° slow-motion hinge for wooden doors
Charnière slow-motion 110° pour portes en bois
110° Zeitlupenband für Holztüren
110° slow-motion scharnier voor houten deuren
bisagra 110° slow-motion para puerta en madera

forms

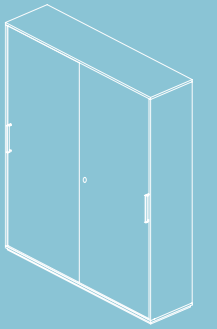
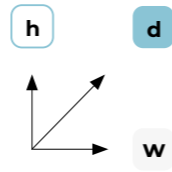

ASL

melaminico/laccato opaco, melamine (lamine)/matt lacquered, mélamine/lacqué mat, melamin/matt lackiert, melamine/mat gelakt, melamina/laqueado mate

d: 46 cm
d: 18"

w: 102,4 cm
w: 40 1/4"

w: 202,4 cm
w: 79 3/4"

h: 71,7 cm
h: 28 1/4"

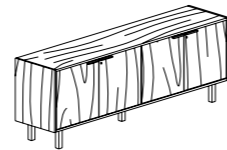
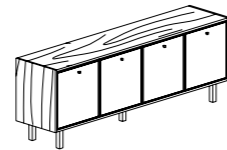
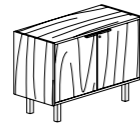
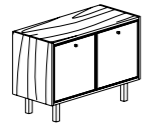

h: 122,9 cm
h: 28 1/4"

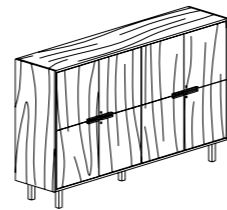
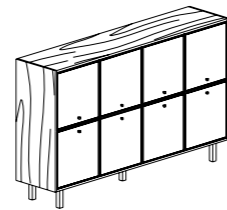
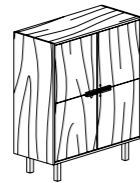
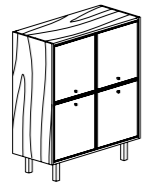

legno, wood, bois, Holzfurnier, hout, madera

d: 46 cm
d: 18"

w: 102,7 cm
w: 40 1/2"

w: 202,7 cm
w: 79 3/4"

h: 71,8 cm
h: 28 1/4"

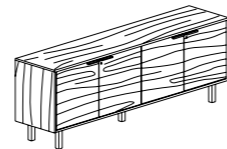
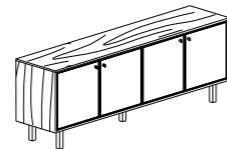
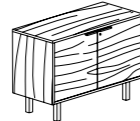
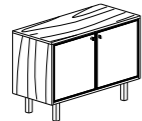

h: 123 cm
h: 48 1/2"

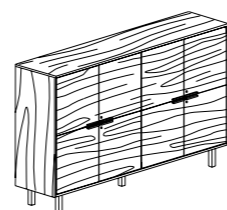
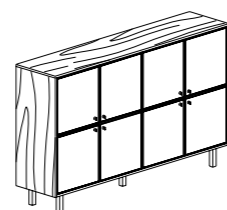
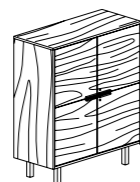
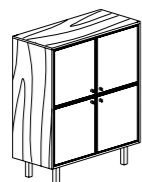





moduli e dimensioni • modules and dimensions •
modules et dimensions • Module und Abmessungen •
modules en afmetingen • módulos y dimensiones



d: 46 cm
d: 18"

d: 48 cm
d: 18 3/4"

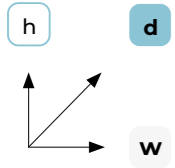

h: 248,8 cm
h: 98"

h: 195,8 cm
h: 77"

h: 157,4 cm
h: 62"

h: 119 cm
h: 46 3/4"

h: 80,6 cm
h: 31 3/4"



numerosa combinazioni di finiture • numerous finishes combinations •
nombreuses combinaisons de finitions • Zahlreiche Kombinationen von Oberflächen •
talrijke combinaties van afwerkingen • muchas combinaciones de acabados

numero finiture, number of finishes, numéro de finitions,
Anzahl Oberflächen, aantal afwerkingen, numero de acabados

15

tessuto
fabric
tissu
Stoff
stof
tejido

1

melaminico
melamine (laminated)
mélamine
melamin
melamine
melamina

1

melaminico
melamine (laminated)
mélamine
melamin
melamine
melamina

10

melaminico
melamine (laminated)
mélamine
melamin
melamine
melamina

componenti e finiture • composants and finishes •
composants et finitions • Bauteile und Oberflächen •
componenten en afwerkingen • componentes y acabados

1

scocca e ripiani, structure and shelves,
structure et étagères, Korpus und Einlegeböden,
omhulsel en schappen, estructura y estantes

melaminico, melamine (lamine), mélamine,
melamin, melamine, melamina

BL

2

ante, doors, portes,
Türen, deuren, puertas

melaminico, melamine (lamine), mélamine,
melamin, melamine, melamina

BL GP GS MK MO
MH AN RN NC WW

3

schiena di finitura, finishing back panel,
dos de finition, Sichrückwand,
afwerking achterkant, trasera de acabado

melaminico, melamine (lamine), mélamine,
melamin, melamine, melamina

BL

tessuto (rivestimento), fabric (covering), tissu (revêtement),
Stoff (Verkleidung), stof (bekleding), tejido (revestimiento)

P1 PG P2 PV P4
P8 X1 X2 X3 A1
A2 A3 A4 A5 A6

4

maniglie, handles, poignées,
Griffe, handgrepen, tiradores

metallo, metal, métal,
metall, metaal, metal

BW AF TF GF NF



semplicità e velocità di montaggio e smontaggio • simple, fast and easy to assemble and
disassemble (K/D) • simplicité et vitesse dans le montage et le démontage • Einfache, schnelle
Montage und Demontage • eenvoudige en snelle montage en demontage • sencillez y velocidad
de montaje y desmontaje

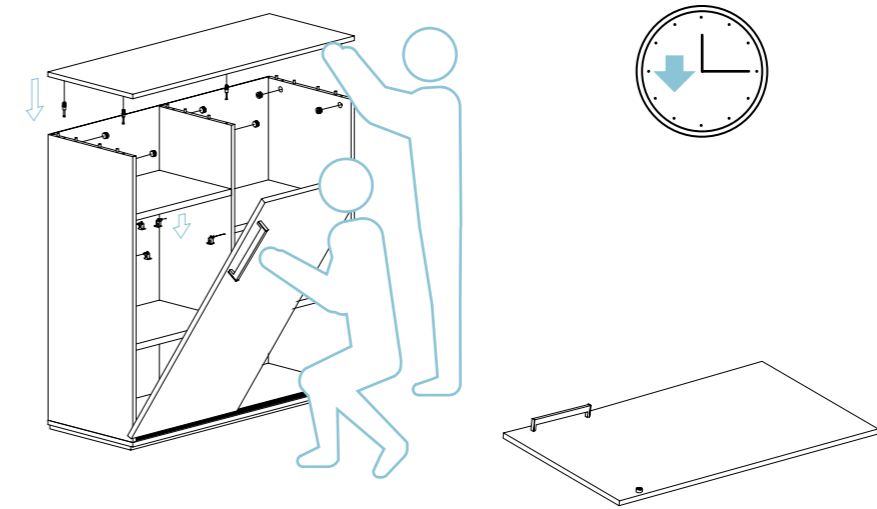

Altezze compatibili con armadi ABA (solo con top 18 mm) • heights compatibles with ABA
cabinets (only with 18 mm top) • hauteurs compatibles avec armoires ABA (uniquement avec top
18 mm) • Höhen kompatibel mit ABA-Schränken (bei Abdeckplatte 18 mm) • hoogtes compatibel
met ABA-kasten (alleen met bovenpaneel van 18 mm) • alturas compatibles con armarios ABA
(solo tapa de 18 mm.)



ASL

ABA

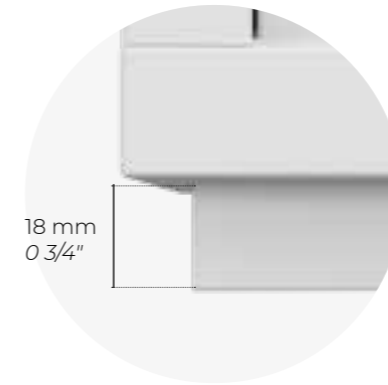

fondo portante antiflessione
no-bending supporting base
base portante anti-flexion
Starre tragende Bodenplatte
anti-flex dragende bodem
fondo maestro anti flexion



binario alluminio verniciato bianco
white painted aluminum rail
rails en métal laqué blanc
weiss lackierte Aluminiumschiene
witgelakte aluminium rail
binario alluminio pintado blanco



reggiripiano (possibilità di fissaggio alla struttura)
shelf support hardware (can be fixed on the frame)
support pour étagère (possibilité de fixation à la structure)
Bodenhalter (am Korpus zu befestigen)
schappensteun (mogelijkheid tot bevestiging aan de structuur)
soporte para estante (posibilidad de ajuste a la pared)



attenuatore di battuta e maniglia
door softener & handle
amortisseur de fermeture et poignée
anschlagdämpfer und Griff
slagdemper en handgreep
actuador de golpe y tirador

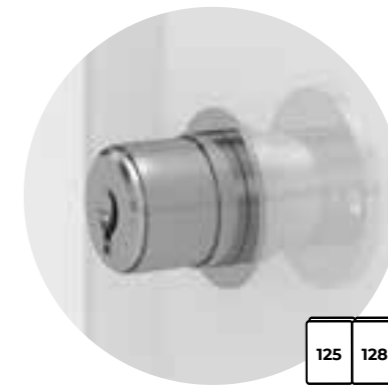

serratura con nottolino estraibile
lock with removable cam
Serrure avec barillet extractible
Abnehmbarer Schlosszylinder
slot met uitneembare pal
cerradura con trinchete extraíble

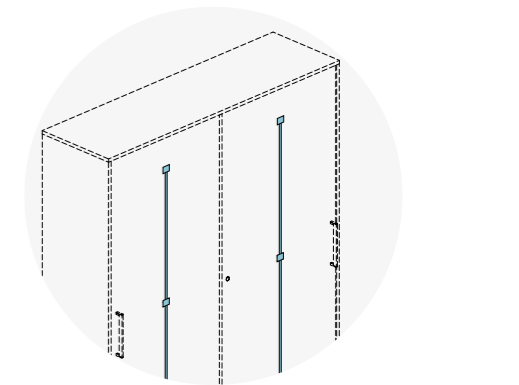

raddrizza ante interno anta h. 160-200 cm
inner door strenghtner h.160-200 cm (63" - 78 3/4")
barre raidisseuse interne pour porte h. 160-200 cm
Innere Türversteifung H.160-200 cm
rechtmaker deur binnenkant deur h. 160-200 cm
endereza puerta interior h. 160-200 cm.

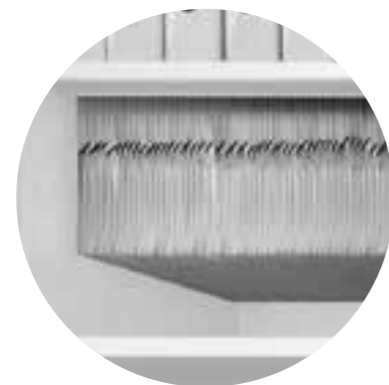

ripiano metallico porta cartelle
metallic shelf file holders
étagère en métal porte DS
Metallboden mit Mappenaufhängung
metalen schap voor mappen
estante metalico para carpetas



schiena di finitura
finishing back panel
dos de finition
Sichrückwand
afwerking achterkant
trasera de acabado



riloga appendiabiti
pull-out coat hanger
portemanteaux extractible
Ausziehbare Kleiderstange
kleerhangerrail
percha extraíble



parapolvere a spazzola montato su anta
brush duster door fixed
cache-poussière à brosse assemblé à la porte
Bürsten-Staubabdichtung, auf Tür montiert
stofkap met borstel gemonteerd op de deur
bloque para polvo con cepillo montado en la puerta

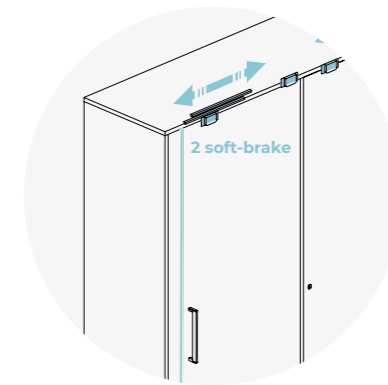

ante con soft open/close
doors with soft opening/closing
portes avec fermeture amortie
Türen mit Anschlagdämpfer
deuren met soft open/close
puertas con soft-system

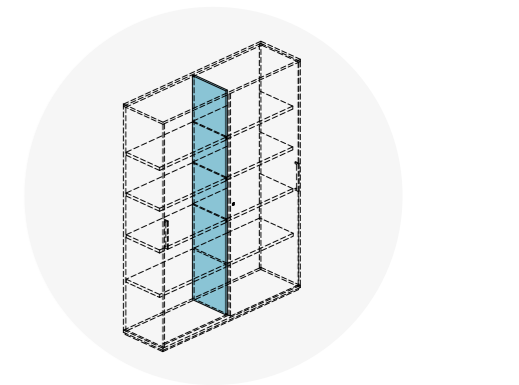

tramezza centrale verticale
vertical central partition
cloison centrale verticale
Vertikale Korpus-Innenaufteilung
verticale, centrale middenwand
tabique central vertical

forms

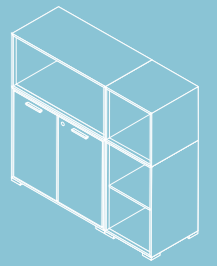

UBI

design:
Gianantonio Perin
Giorgio Tapan

d: 46 cm
d: 18"

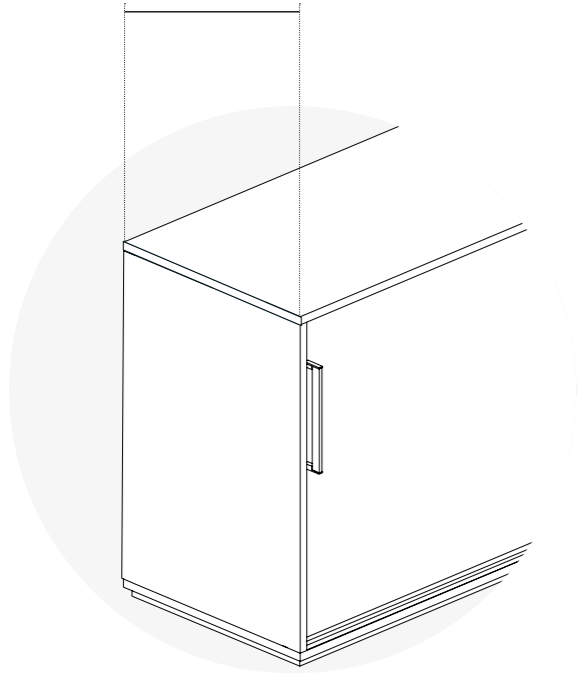

d: 48 cm
d: 18 3/4"

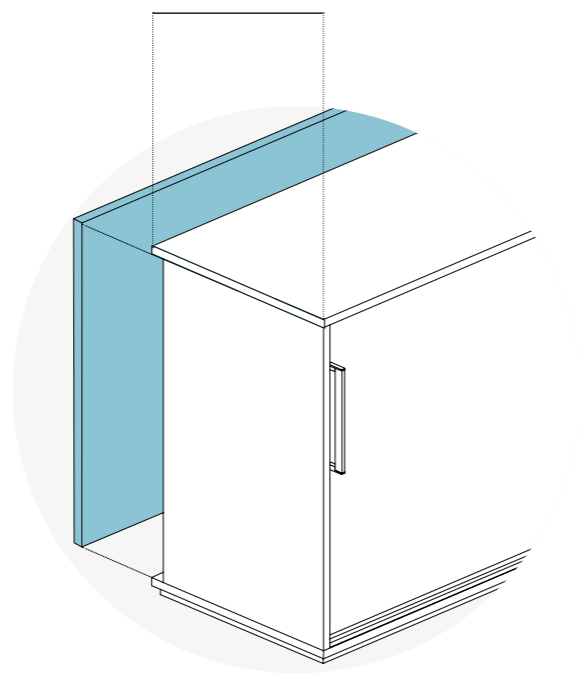

h: 80,6 cm
h: 31 3/4"

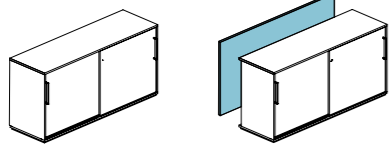

a.

h: 119 cm
h: 46 3/4"

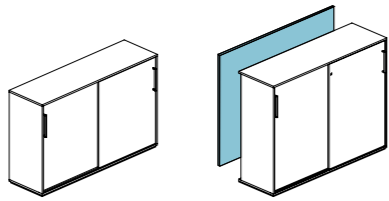

b.

h: 157,4 cm
h: 62"

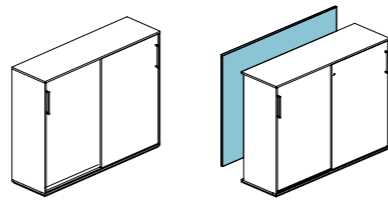

c.

h: 195,8 cm
h: 77"

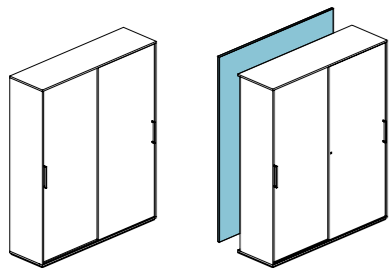

d.

h: 195,8+53 cm
h: 77"+20 3/4"

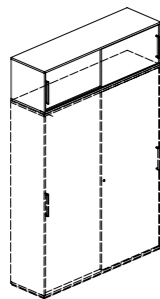

e.

	w	d
a, b, c, d	120 - 160 cm, 47 1/4" - 63"	46-48 cm 18"-18 3/4"
e	120 - 160 cm, 47 1/4" - 63"	46 cm 18"





desk system
p.60-61

storage
p.62

lockers
p.63



freestanding
p.62

waiting
p.63

desk system



elettrificazione, electrification, électrification, Elektrifikation, elektrificatie, electrificación

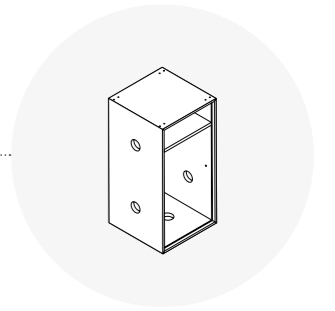
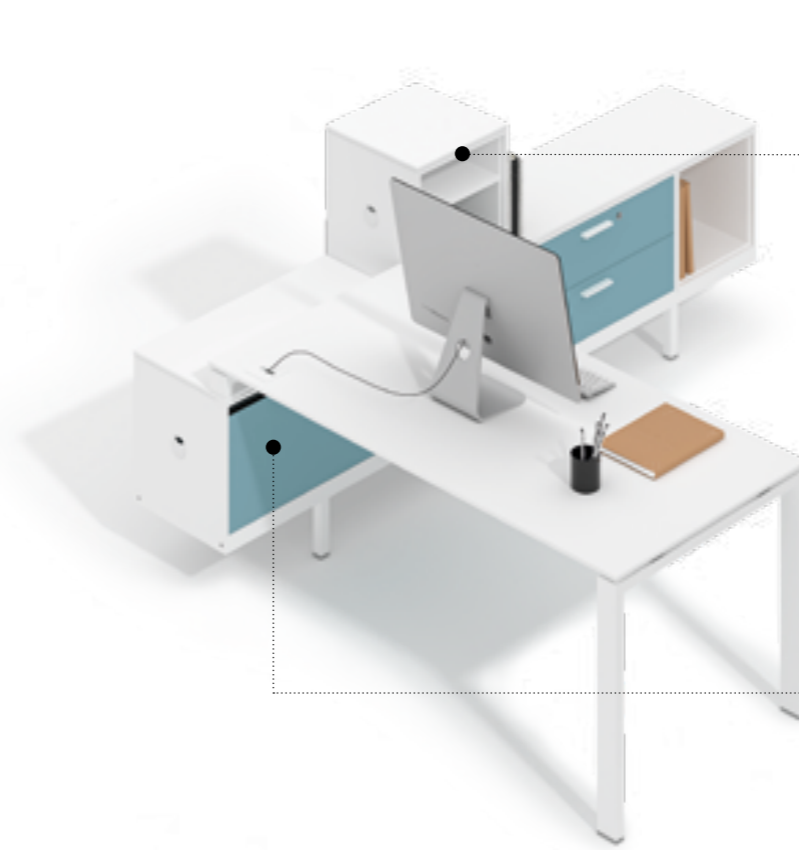

modulo tecnico verticale
vertical technical module
module technique vertical
vertikales technisches Modul
verticale technische module
módulo técnico vertical

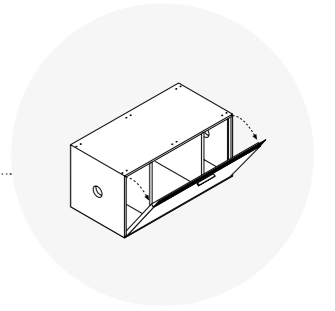

modulo tecnico orizzontale
horizontal technical module
module technique horizontal
Horizontales technisches Modul
horizontale technische module
módulo técnico horizontal

configurazioni, layouts, configurations, Konfigurationen, configuraties, configuraciones



a.

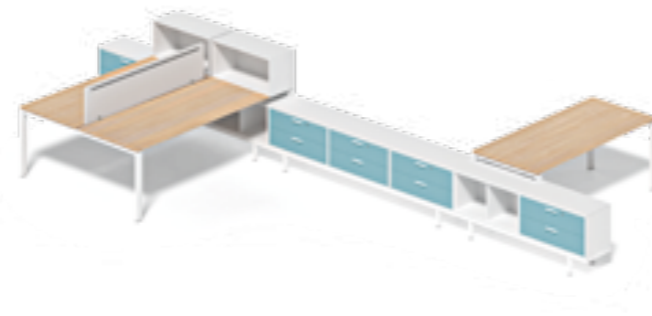

b.



c.



d.

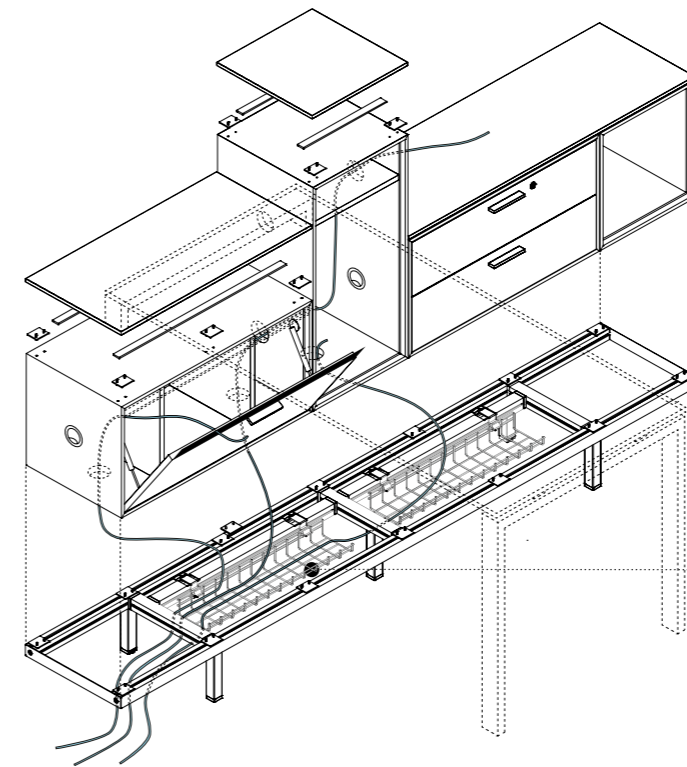

passaggio cavi su podio
stand cable/wire management
passage de câbles sur podium
Kabelführung im Podest
kabeldoorgang op podium
pasacables sobre podio

storage



lockers



chiusura con combinazione
 combination locking system
 fermeture avec combinaison
 Schliessung mit Kombination
 sluiting met combinatie
 cerradura con combinacion

chiusura con serratura
 key locking system
 fermeture avec serrure
 Schliessung mit Schloss
 sluiting met slot
 cerrada con cerradura

fessura per documenti
 document slot
 fente pour documents
 Schlitzwurf
 gleuf voor documenten
 hendidura para documentos

Ripiano anticaduta documento
 falling paper prevention shelf
 Étagère pour éviter la chute des papiers
 Einlegeboden mit Einwurfschlitz
 Legbord ter voorkoming dat papier erdoor valt
 Estante de anti-caída de documento

barre di fissaggio
 fixing bars
 barre d'assemblage
 Befestigungstraverse
 bevestigingsbalken
 barras de ajuste

freestanding



waiting





assemblaggio veloce • quickly assembly • assemblage rapide • Schnellmontage • snelle montage • montaje rapido

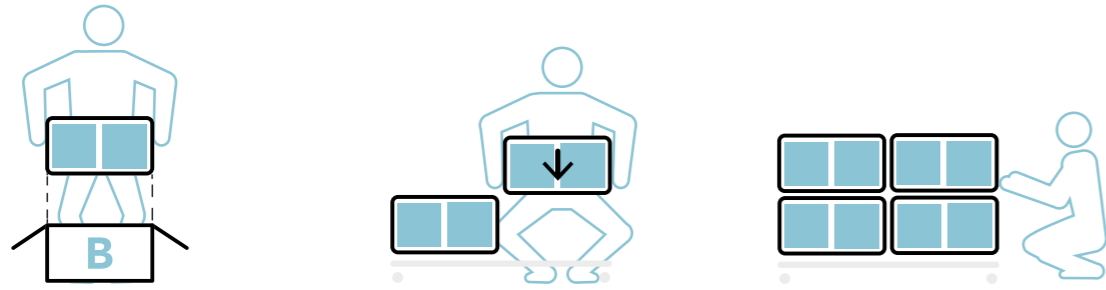

moduli Ubi consegnati montati
 Ubi modules delivered assembled
 modules Ubi livrés montés
 Ubi-Module werden montiert geliefert
 Ubi-modules gemonteerd geleverd
 módulos UBI entregados montados

assemblaggio senza utilizzo di ferramenta
 assembling without hardware
 assemblage sans quincaillerie
 Montage ohne Metallbeschläge
 montage zonder gebruik van gereedschap
 montaje sin opción de herraje

variabilità futura della composizione
 future variability of the composition
 variabilité future des compositions
 Kompositionen lassen sich nachträglich verändern
 toekomstige variabiliteit van de compositie
 variabilidad futura de la composición

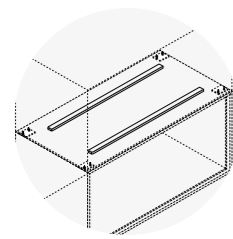

Coppia barre di fissaggio, antiflessione ed oscuramento
 pair of fixing, non flexion and darkening rails
 paire de barres d'assemblage, anti-flexion et pour obscurissement
 Paar Befestigungstraverse, versteifungs- und Verdunklungstraversen
 paar bevestigingsbalken voor anti-flex en verduistering
 par de barras de ajuste, anti flexion y oscurecimiento

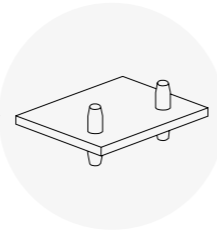
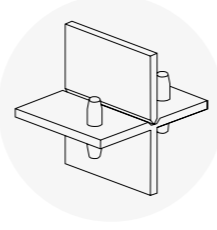
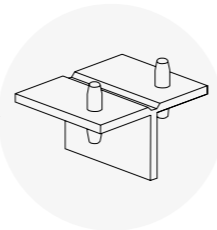
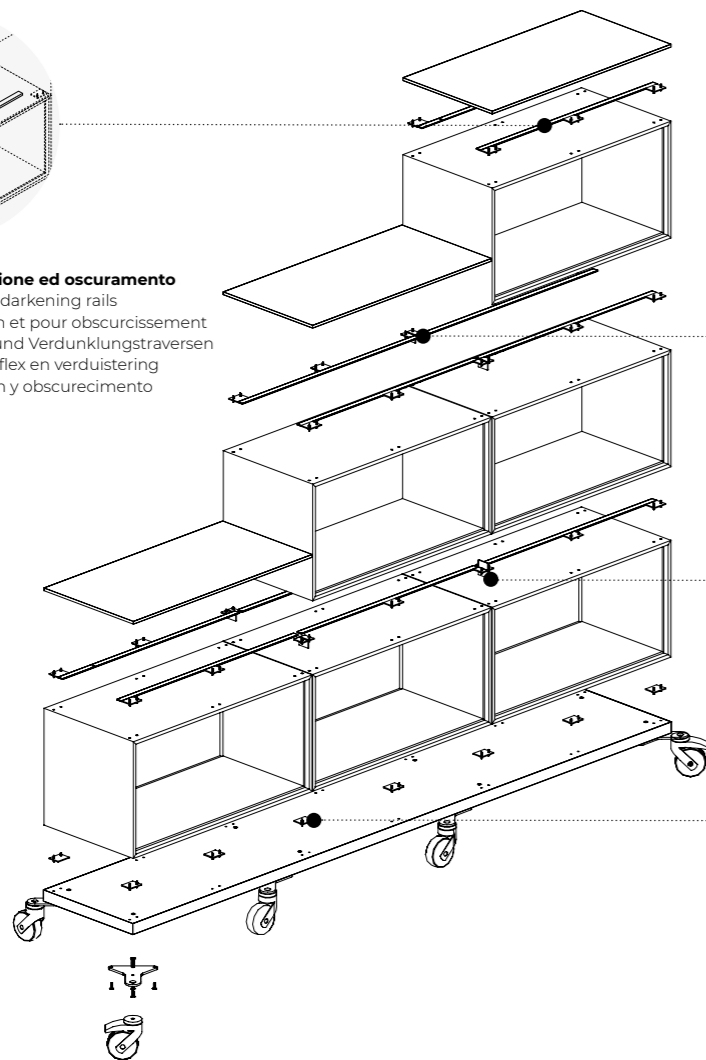

giunzione rapida
 quick joining
 jonction rapide
 Schnellverkopplung
 snelle aansluiting
 conexión rapida

componibilità • modularity • composable • Kombinierbarkeit • modulariteit • componibilidad

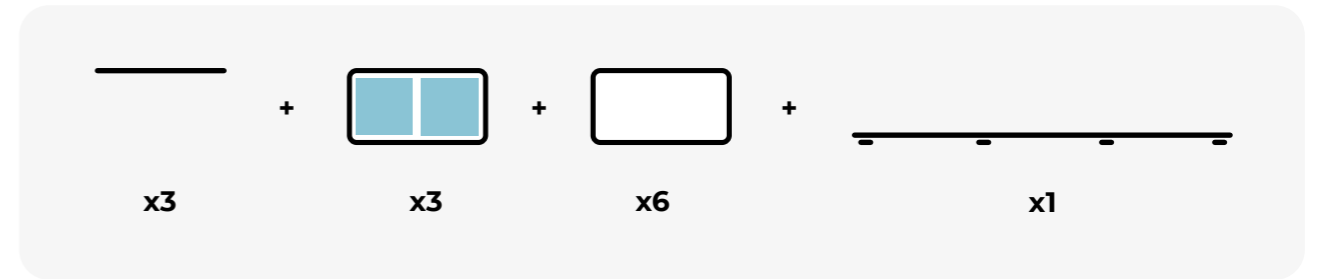

componenti e finiture • components and finishes • composants et finitions •
Bauteile und Oberflächen • componenten en afwerkingen • componentes y acabados

scocca, schiena, ripiano e top; structure, back, shelf and top;
structure, dos, étagère et top; Gestell, Rückwand, Fachboden und
Abdeckplatte; omhulsel, achterkant, schap en bovenpaneel;
estructura, trasera, estante y tapa

melaminico, melamine (lamine), mélamine,
melamin, melamine, melamina



laccato opaco, matt lacquered, lacqué mat,
matt lackiert, mat gelakt, laqueado mate

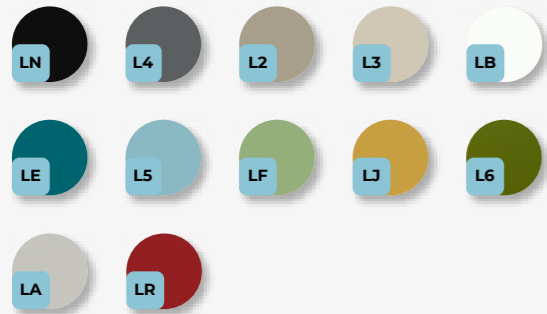

sistema step forming®
step forming® system
système step forming®
Step-Forming System
step forming®-systeem
sistema step forming®



45° folding
45° folding
liaison à 45°
45° Biegung
45° folding
45° folding

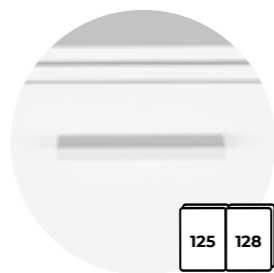

maniglie
handles
poignées
Griffe
handgrepen
tiradores

ante e frontali, doors and frontals, portes et façades, Türen und
Stirnseiten, deuren en voorpanelen, puertas y frontales

melaminico, melamine (lamine), mélamine,
melamin, melamine, melamina

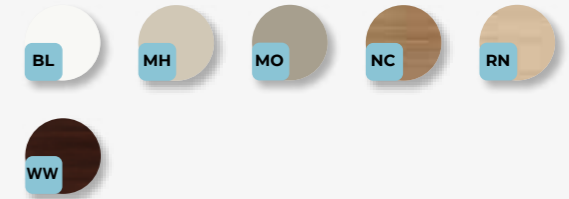

laccato opaco, matt lacquered, lacqué mat,
matt lackiert, mat gelakt, laqueado mate



metacrilato, methacrylate, méthacrylate,
Methacrylat, methacrylaat, metacrilato



plastica, plastic, plastique,
Plastik, kunststof, plàstica



podio, podium, podium,
Podest, podium, podio

melaminico, melamine (lamine), mélamine,
melamin, melamine, melamina



parti metalliche, metallic parts, parties métalliques,
Metallteile, metalen onderdelen, partes metalicas



numerosa combinazioni di finiture • numerous finishes combinations •
nombreuses combinaisons de finitions • Zahlreiche Kombinationen von Oberflächen •
talrijke combinaties van afwerkingen • muchas combinaciones de acabados

numero finiture, number of finishes, número de finitions,
Anzahl Oberflächen, aantal afwerkingen, numero de acabados

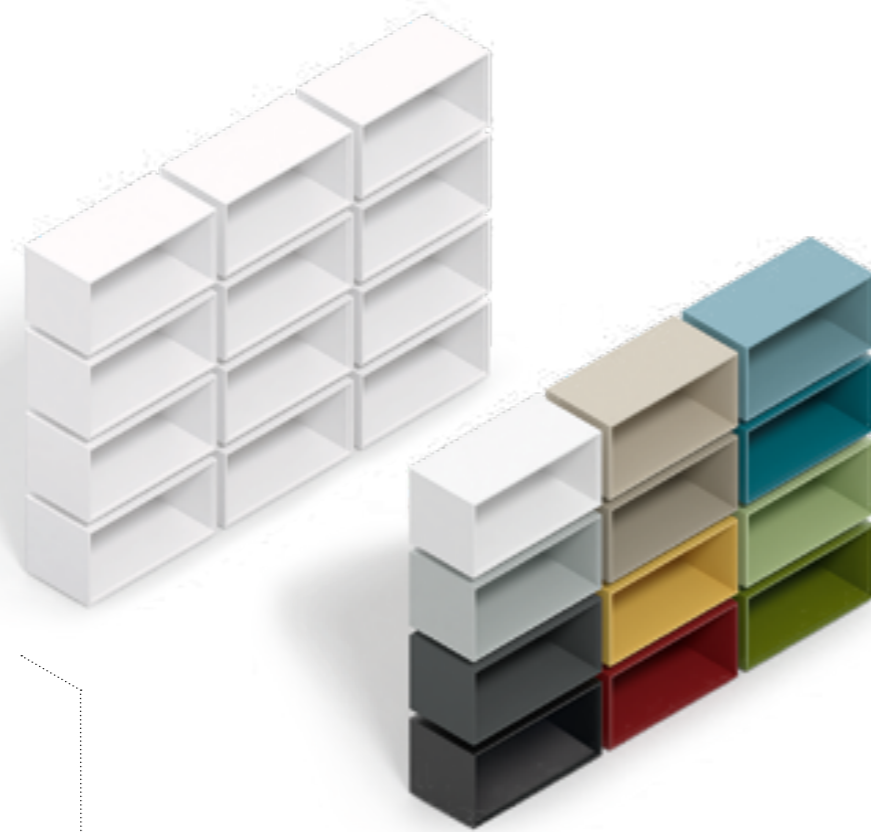

1

melaminico
melamine (laminated)
mélamine
melamin
melamine
melamina

12

laccato opaco
matt lacquered
lacqué mat
matt lackiert
mat gelakt
laqueado mate

12

laccato opaco
matt lacquered
lacqué mat
matt lackiert
mat gelakt
laqueado mate

6

melaminico
melamine (laminated)
mélamine
melamin
melamine
melamina

3

metacrilato
methacrylate
méthacrylate
Methacrylat
methacrylaat
metacrilato



accessori • accessories • accessoires •
Zubehör • accessoires • accesorios

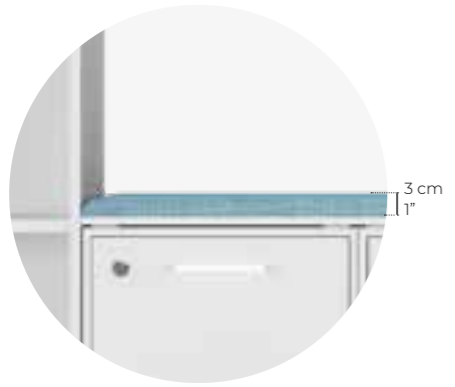

cuscinò
pillow
cousin
Kissen
kussen
cojín

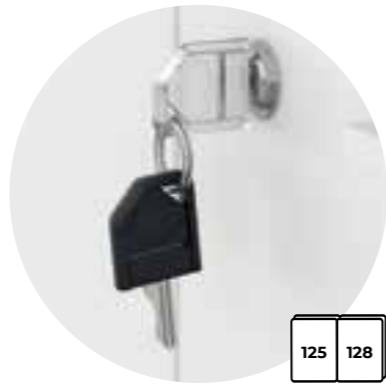

coppia chiavi pieghevoli
pair of foldable keys
paire de clés pliantes
Paar faltbare Schlüssel
paar vouwbare sleutels
par de llaves plegables

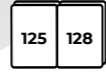

piano consultazione
briefing top
plateau de consultation
Besprechungsplatte
schema voor advies
plano conversacion



cassetto
drawer
tiroir
Schublade
lade
cajón



mobile porta CPU
cpu storage
meuble porte cpu
Computerträger
meubel voor CPU
mueble porta CPU



schiena proteggi cavi
cable management protection back
dos protège-câbles
Kabel-Schutzwand
achterkant voor kabelbescherming
traserera para proteger los cables



fondo per cassetto classificatore (consultare il listino)
filing drawer bottom (see price list)
fond pour tiroir extractible (voir la liste des prix)
Bodenplatte für Hängeauszug (siehe Preisliste)
bodem voor archieflade (zie prijslijst)
fondo para cajón archivo (ver lista de precios)



coppia barre portacartelle
pair of file carrier bars
paire de barres porte-dossiers suspendues
ein paar Hängeregisterträger
koppel dossierdragende balken
par de barras portacarpetas colgadas



vasca portapiante con vaschetta metallica salvagoccia
plant vat with metal water tank
bac pour plantes avec base métallique de protection d'eau
Pflanzentrog mit Metall-Abtropfschutzwanne
plantenbak met metalen lekbakje
cubeta para plantas con cubeta metalica para gotas



antine a scorrere in metacrilato
methacrylate sliding doors
portes coulissantes de méthacrylate
Schiebetüren aus Methacrylat
methacrylaat schuifdeurtjes
puertas correderas metacrilato



persiana con serratura
rolling shutter
volet roulant
Jalousie mit Schloss
rolluik met slot
persiana con cerradura



pannello compensatore verticale
vertical compensatory panel
panneau de compensation vertical
vertikales Ausgleichspaneel
verticaal compensatiepaneel
panel de compensación vertical

forms

moduli, modules, modules,
Module, modules, módulos

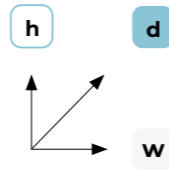

d: 40 cm
d: 15 3/4"

w: 39,8 cm
w: 15 3/4"

w: 80 cm
w: 31 1/2"

h: 19,7 cm
h: 7 3/4"

h: 39,8 cm
h: 15 3/4"

h: 59,7 cm
h: 23 1/2"

h: 69,1 cm
h: 27 1/4"

Ubi base
Ubi base
Ubi base
Basisbehälter Ubi
Ubi-bodem
Ubi de base

h: 80 cm
h: 31 1/2"

h: 160,3 cm
h: 63"

***Locker**

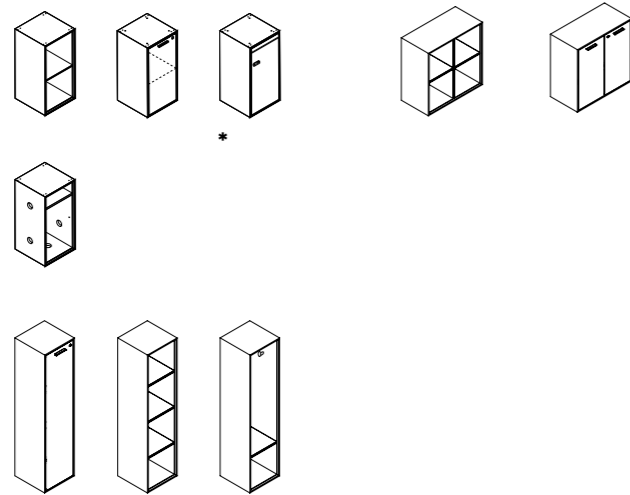
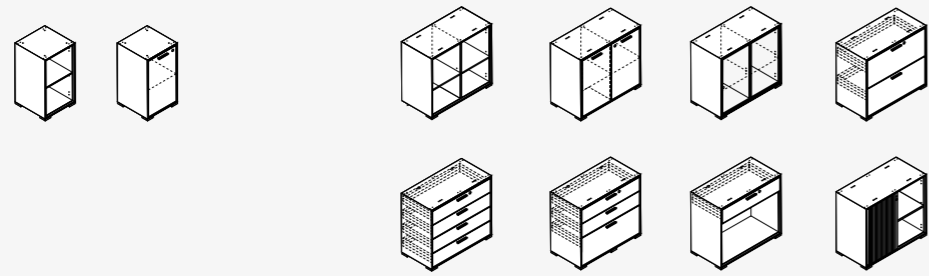
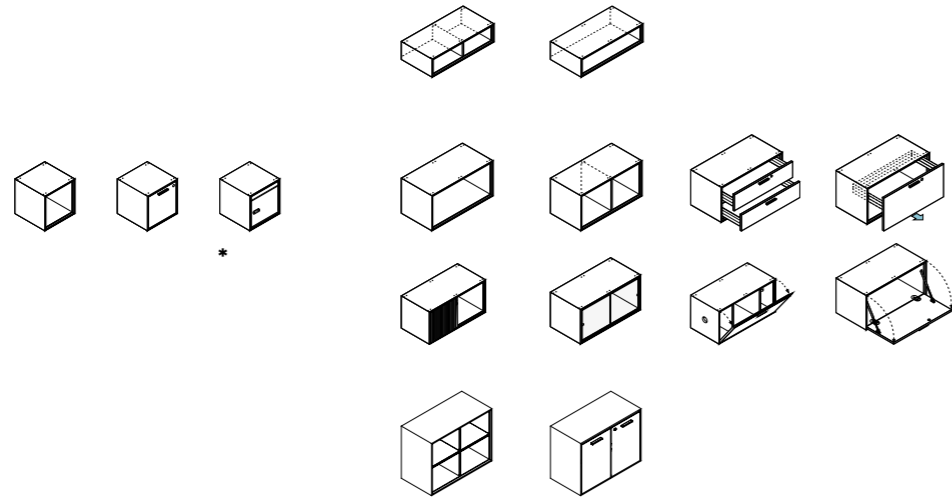

top, top, top,
Abdeckplatte, bovenpaneel, Tapa

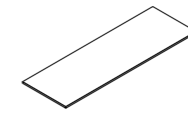

podio, podium, podium,
Podest, podium, podio

h: 5 cm
h: 2"



h: 17,8 cm
h: 7"



h: 21,6 cm
h: 8 1/2"



h: 44 cm
h: 17 1/4"



vasca porta piante, plants holder tank, bac pour plantes,
pflanzenrog, Pflanzenbak, contenedor para plantas

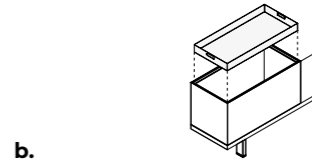
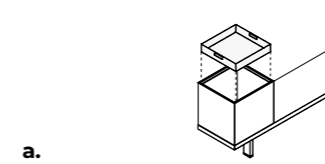

cusino, pillow, coussin,
Kissen, kussen, cojín

h: 20 cm
h: 7 3/4"

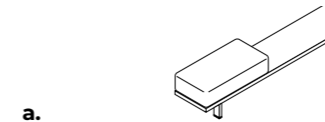

h: 6 cm
h: 2 1/4"

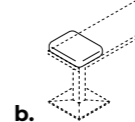

h: 3 cm
h: 1"

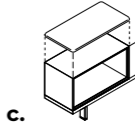

carrello, trolley, chariot,
Wagen, trolley, carro

h: 99,5 cm
h: 39"



h: 139,6 cm
h: 55"

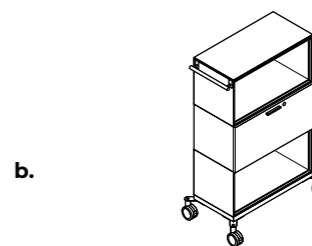

h: 1,2 cm
h: 0 1/2"

w	d
40,1 - 240,9 cm 15 3/4"-94 3/4"	40 cm 15 3/4"

	w	d
a.	80,3-240,9 cm 31 3/4"-94 3/4"	40 cm 15 3/4"
b.	119,7-240,2 cm 47"-94 1/2"	40 cm 15 3/4"
c.	90,3-250,9 cm 35 1/2"-98 3/4"	40 cm 15 3/4"
d.	160,6-240,9 cm 63 1/4"-94 3/4"	40 cm 15 3/4"

h: 39,8 cm
h: 15 3/4"

	w	d
a.	40 cm 15 3/4"	40 cm 15 3/4"
b.	80 cm 31 1/2"	40 cm 15 3/4"

	w	d
a.	80 cm 31 1/2"	40 cm 15 3/4"
b.	40 cm 15 3/4"	53 cm 20 3/4"
c.	80 cm 31 1/2"	40 cm 15 3/4"

	w	d
a, b	80 cm 31 1/2"	40 cm 15 3/4"

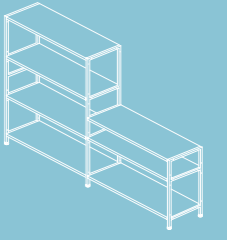

CONCERTO

design:
Gianantonio Perin
Monica Fernandes





desk system
p.84-85

storage
p.86

lockers



freestanding
p.87

waiting
p.87

desk system



Concerto + Ubi

w: 80 cm
w: 31 1/2"

w: 39,8 cm
w: 15 3/4"

w: 80 cm
w: 31 1/2"

w: 80 cm
w: 31 1/2"

h: 19,7 cm
h: 7 3/4"

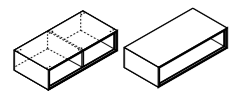

h: 39,8 cm
h: 15 3/4"

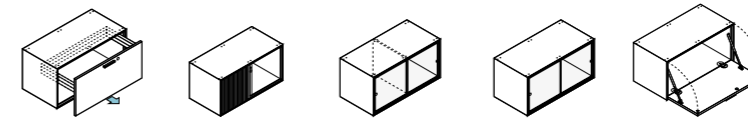
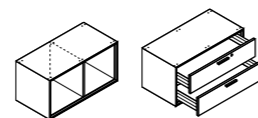
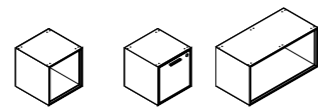

h: 59,7 cm
h: 23 1/2"

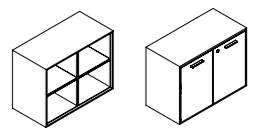

storage



waiting



freestanding



componenti e finiture • components and finishes •
 composants et finitions • Bauteile und Oberflächen •
 componenten en afwerkingen • componentes y acabados

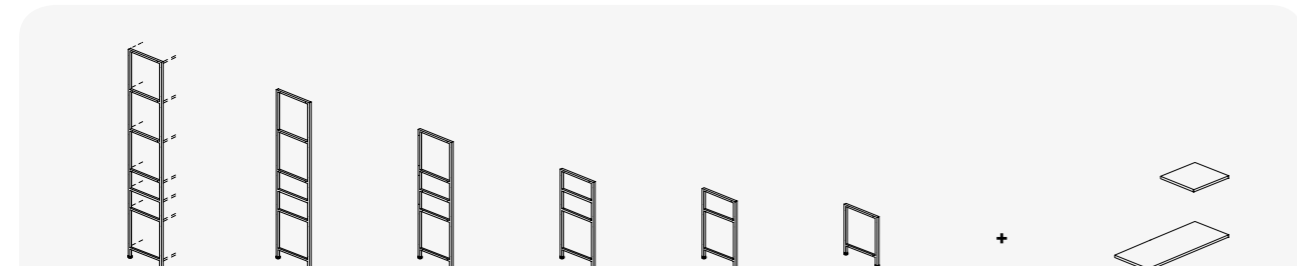

facilità di montaggio
 easy to assembly
 simplicité de montage
 Einfache Montage
 gemakkelijk te monteren
 facilidad de montaje

trasformabilità
 convertibility
 transformabilité
 Verwandelbarkeit
 convertibiliteit
 transformabilidad

accessori • accessories • accessoires •
 Zubehör • accessoires • accesorios

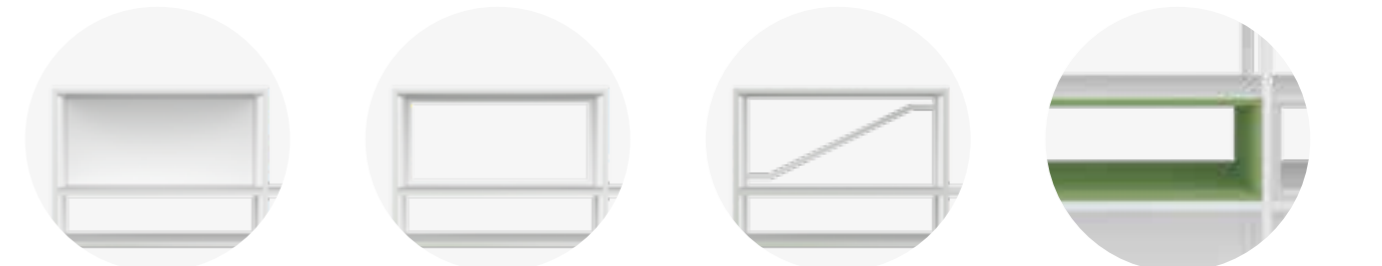

schiena
 back
 dos
 Rückwand
 achterkant
 trasera

schiena
 back
 dos
 Rückwand
 achterkant
 trasera

schiena
 back
 dos
 Rückwand
 achterkant
 trasera

top metallico obbligatorio per Ubi
 metal top compulsory for Ubi
 top métallique obligatoire pour Ubi
 Abdeckplatte obligatorisch aus Metall für Ubi
 metalen bovenpaneel verplicht voor Ubi
 tapa metálica obligatoria para Ubi

fianchi e top metallico, metallic top and sides,
 flancs et top métalliques, Abdeckung und Seitenverkleidungen aus Metall, metalen zij- en bovenpanelen, tapa y costados metalicos

metallo, metal, métal,
 metall, metaal, metal



schiena, back,
 dos, Rückwand,
 achterkant, trasera

metallo, metal, métal,
 metall, metaal, metal

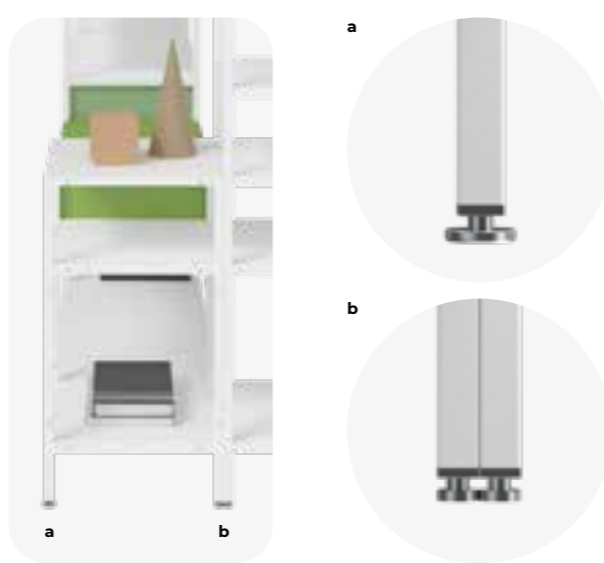

melaminico, melamine (laminated), mélamine,
 melamin, melamine, melamina

modulo ad angolo
 corner module
 module angulaire
 Winkelmodul
 hoekmodule
 módulo angular

pedini Concerto (b per angolo)
 Concerto feet (b for angle)
 vérins Concerto (b pour l'angle)
 Füßchen Concerto (b für den Winkel)
 Concerto-poten (b voor hoek)
 pies de Concerto (b para el ángulo)

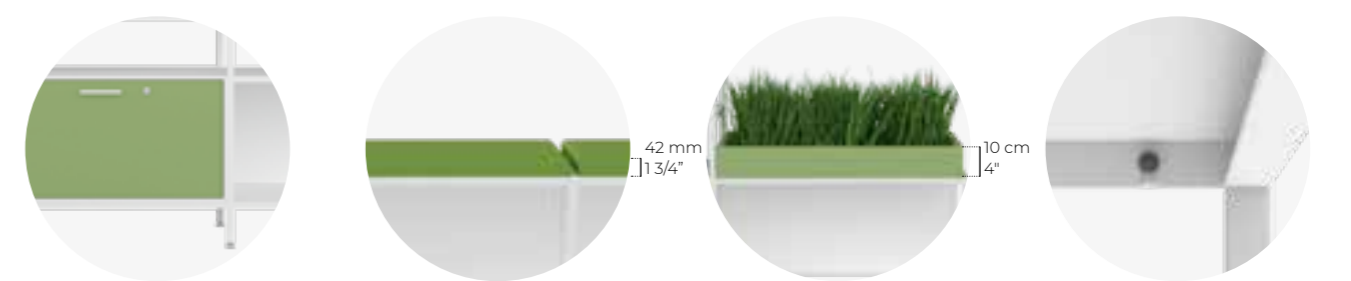

Ubi orizzontale
 horizontal Ubi
 Ubi horizontal
 Ubi horizontal
 horizontale Ubi
 Ubi horizontal

cuscin
 pillow
 coussin
 Kissen
 kussen
 cojín

contenitore
 storage unit
 conteneur
 Behälter
 houder
 recipiente

attacco rapido
 quick coupling
 fixation rapide
 Schnellanbindung
 houder
 enganche rapido

Concerto monochromatic

bianco, white, blanc,
weiß, wit, bianco



concerto



gambe, legs, piètements,
Beine, poot, patas



piano, top, plan,
platte, blad, plano

Concerto monochromatic

nero, black, noir,
schwarz, zwart, negro



concerto



gambe, legs, piètements,
Beine, poot, patas



piano, top, plan,
platte, blad, plano

titanio, titanium, titane,
titan, titanium, titanio



concerto



gambe, legs, piètements,
Beine, poot, patas



piano, top, plan,
platte, blad, plano

metallo crudo, raw metal, métal brut,
rohes metall, onbehandeld metaal, metal tosco



concerto



gambe, legs, piètements,
Beine, poot, patas



piano, top, plan,
platte, blad, plano

tortora, turtledove, tourterelle,
turteltaube, tortelduif, tórtola



concerto



gambe, legs, piètements,
Beine, poot, patas



piano, top, plan,
platte, blad, plano



forms

fianco telaio dx=sx, frame rh=lh, châssis dr=ga,
Rahmen re=li, frame zijpaneel rechts=links, bastidor dcho=izdo

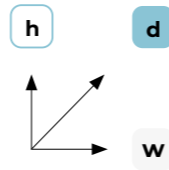

d: 40 cm d: 15 3/4"	h: 54,1 cm h: 21 1/4"	h: 74 cm h: 29"	h: 94 cm h: 37"	h: 133,9 cm h: 52 3/4"	h: 173,8 cm h: 68 1/2"	h: 213,7 cm h: 84"
--------------------------------------	--	----------------------------------	----------------------------------	---	---	-------------------------------------

w: 2 cm,
w: 0 3/4"

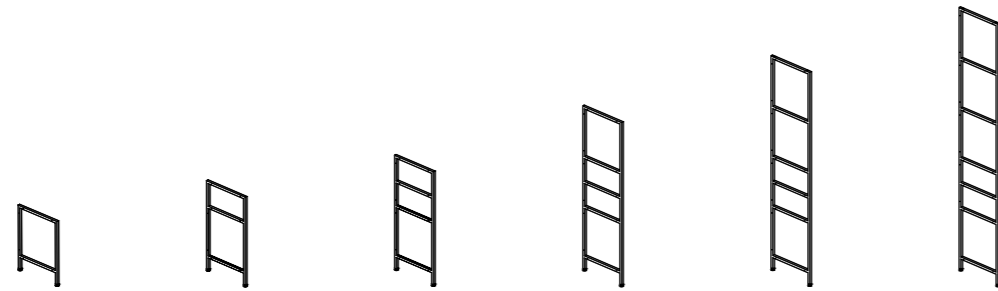

ripiano metallico, metal shelf, étagère en métal,
Regal aus Metall, metalen schap, estante metálico

schiena, back, dos,
Rückwand, achterkant, trasera

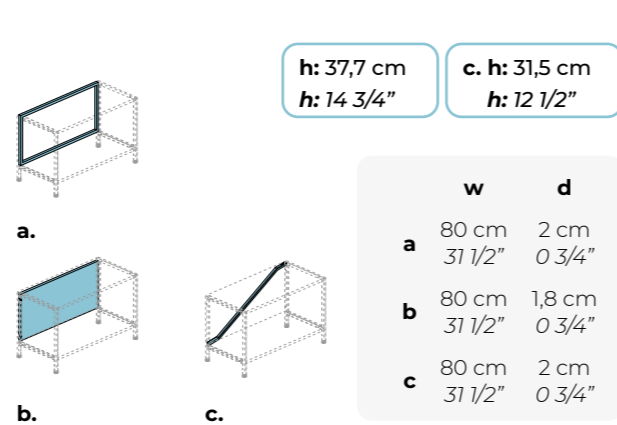
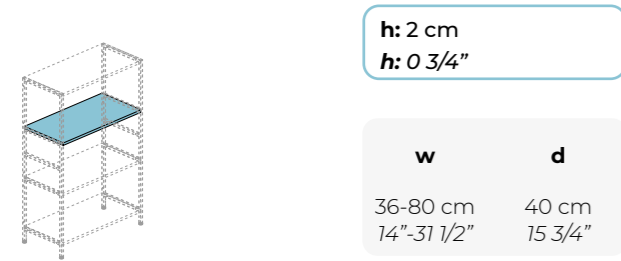

cuscino, pillow, coussin,
Kissen, kussen, cojín

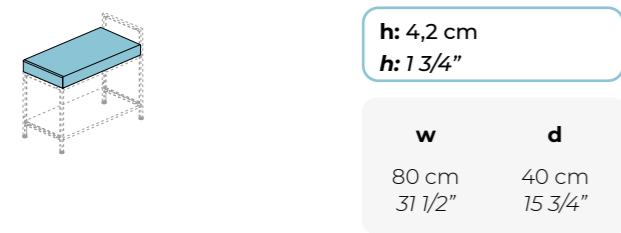

top metallico per Ubi, metal top for Ubi, top métallique pour Ubi, Ab-
deckplatte aus Metall für Ubi, metalen
bovenpaneel voor Ubi, tapa metálica para Ubi

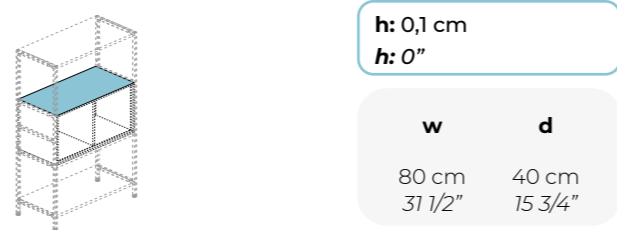

contenitore, storage unit, conteneur,
Behälter, houder, recipiente

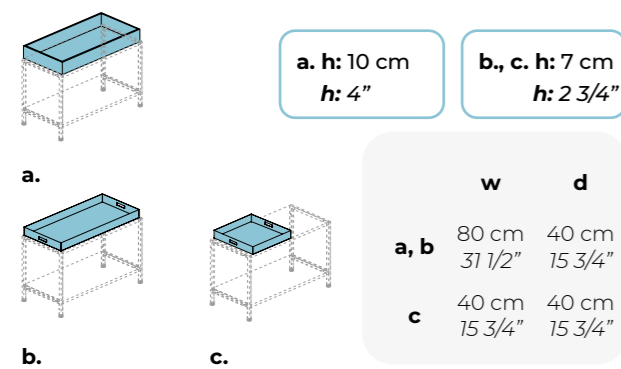

tavolini, tables,
tables, Tischchen,
tafeltjes, mesas pequeñas

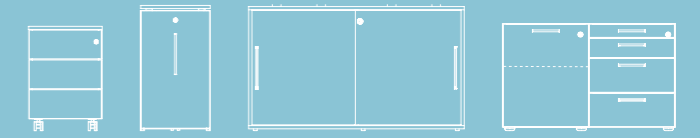
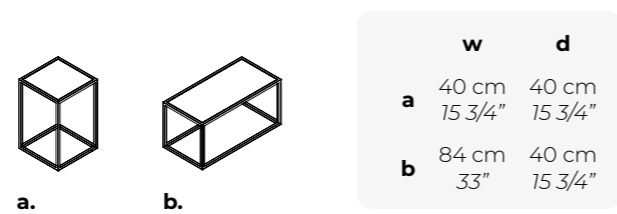

OPERATIVE
100-109



EXECUTIVE
110-115



METAL
116-119



EKO
120-124



NEW

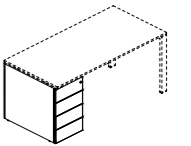
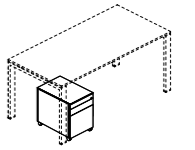

vertical files

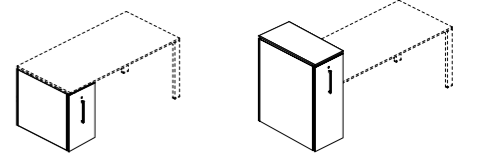

mobili sottoscrivania, support modules, meubles sous bureau, Stützcontainer, meubels voor onder het bureau, módulos de apoyo

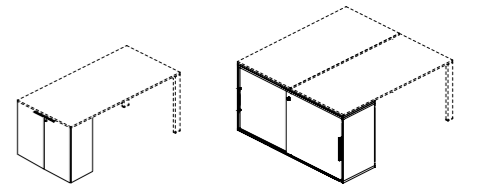

CADI.OP

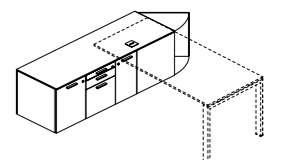
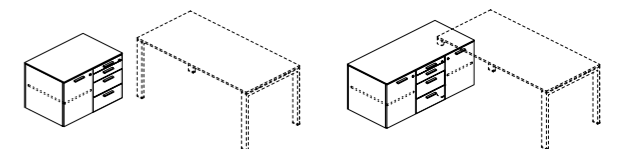

NEW slim

w: 31,8 - w: 12 1/2"



scocca e frontali, structure and frontals, structure et façades, Korpus und Stirnseiten, omhulsel en voorpanelen, estructura y frontales

melaminico, melamine (laminated), mélamine, melamin, melamine, melamina



***solo frontali e top**, *only frontals and top, *seulement façades et top, *nur Front und Abdeckplatte, alleen voorpanelen en bovenpaneel, *sólo frontales y tapa



cassetti interni, internal drawer, tiroirs intérieurs, Schubladenwannen, binnenlades, cajones interiores

melaminico, melamine (laminated), mélamine, melamin, melamine, melamina



h: 58,7 cm
h: 23"

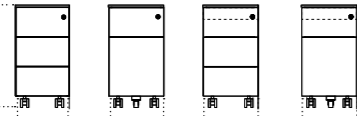

d: 56,3 cm
d: 22"

w: 31,8
w: 12 1/2"

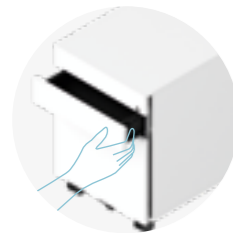

cassetti con presa laterale
no-handle drawers
tiroirs avec prise latérale
Schubladen mit seitlichem Griff
lades met zijgreep
cajones con agarrador lateral



sistema antiribaltamento
anti-tilt system
système anti-basculement
Kippsicherung
kantelbeveiligingssysteem
sistema anti vuelco

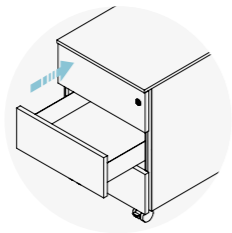

chiusura soft di serie
soft closing as standard
fermeture amortie en standard
Serienmäßige Anschlagdämpfer
standaard sluiting soft
cerrada soft de serie



cassetto portacancelleria
stationery tray
bac tiroir
Utensilienauszug
lade voor benodigdheden
cajon para papeleria

NEW

w: 41,8 cm - w: 16 1/2"



scocca e frontali, structure and frontals, structure et façades, Korpus und Stirnseiten, omhulsel en voorpanelen, estructura y frontales

melaminico, melamine (laminated), mélamine, melamin, melamine, melamina



***solo frontali e top**, *only frontals and top, *seulement façades et top, *nur Front und Abdeckplatte, alleen voorpanelen en bovenpaneel, *sólo frontales y tapa



cassetti interni, internal drawer, tiroirs intérieurs, Schubladenwannen, binnenlades, cajones interiores

melaminico, melamine (laminated), mélamine, melamin, melamine, melamina



metallo, metal, métal, metall, metaal, metal



h: 58,7 cm
h: 23"

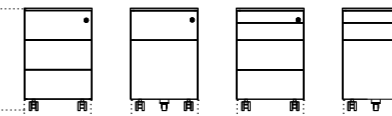

d: 56,3 cm
d: 22"

w: 41,8 cm
w: 16 1/2"

h: 69-70,7* cm
h: 27"-27 3/4*"

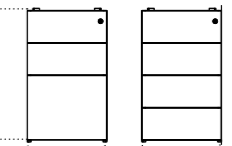

*only for Winglet

d: 60-80 cm
d: 23 3/4"-31 1/2"

w: 41,8 cm
w: 16 1/2"

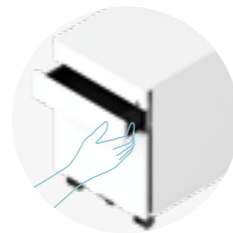

cassetti con presa laterale
no-handle drawers
tiroirs avec prise latérale
Schubladen mit seitlichem Griff
lades met zijgreep
cajones con agarrador lateral



sistema antiribaltamento
anti-tilt system
système anti-basculement
Kippsicherung
kantelbeveiligingssysteem
sistema anti vuelco

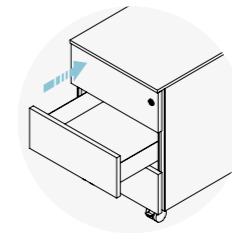

chiusura soft di serie
soft closing as standard
fermeture amortie en standard
Serienmäßige Anschlagdämpfer
standaard sluiting soft
cerrada soft de serie



cassetto portacancelleria
stationery tray
bac tiroir
Utensilienauszug
lade voor benodigdheden
cajon para papeleria



separatori per cassetti metallici
separators for metal drawers
séparateurs pour tiroirs métallique
Trennblätter für Metallschubladen
scheidens voor metalen laden
separadores para cajones metalicos



vaschetta porta cancelleria
stationery tray
plumier
Utensilienschale
bak voor benodigdheden
bandeja para papeleria



fondo per telaio estraibile
bottom for files frame
fond pour cadre extractible
Bodenplatte für Hängeauszug
bodem voor uitneembaar frame
fondo para extraible



cuscino
pillow
coussin
Kissen
kussen
cojin

vertical files

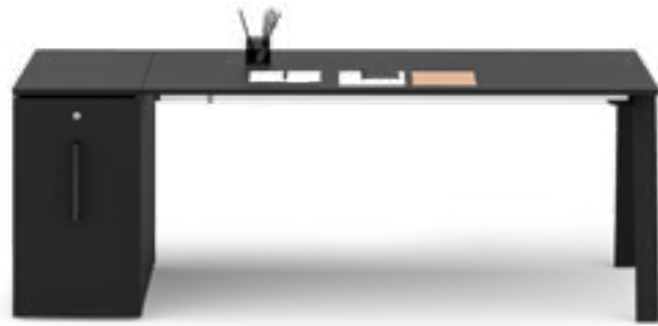

vertical files



finitura, finish, finition,
Oberfläche, afwerking, acabado

melaminico, melamine (laminated), mélamine,
melamin, melamine, melamina



***solo frontale**, only frontal, seulement frontal,
nur Frontal, alleen voorpaneel, sólo frontal

interno, internal, interne,
innere, intern, interior

melaminico, melamine (laminated), mélamine,
melamin, melamine, melamina



maniglie in metallo, metal handles, poignées en métal,
Metallgriffe, metalen handgrepen, tiradores metálicos



finitura, finish, finition,
Oberfläche, afwerking, acabado

melaminico, melamine (laminated), mélamine,
melamin, melamine, melamina

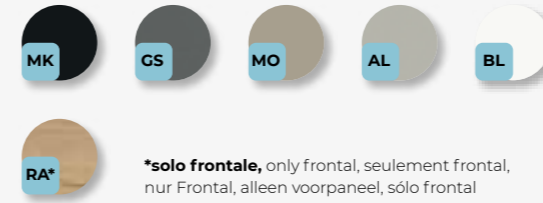

***solo frontale**, only frontal, seulement frontal,
nur Frontal, alleen voorpaneel, sólo frontal

interno, internal, interne,
innere, intern, interior

melaminico, melamine (laminated), mélamine,
melamin, melamine, melamina



maniglie in metallo, metal handles, poignées en métal,
Metallgriffe, metalen handgrepen, tiradores metálicos



vertical file DX o SX

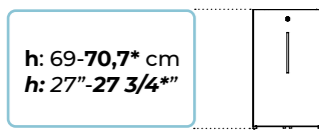

h: 69-70,7* cm
h: 27"-27 3/4*"

*only for Winglet

d: 40 cm
d: 15 3/4"

w: 80 cm
w: 31 1/2"



vaschetta porta cancelleria
stationery tray
plumier
Utensilienschale
bak voor benodigdheden
bandeja para papeleria

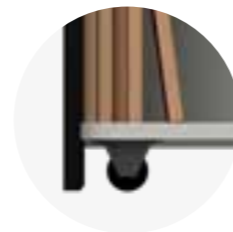

ruota di supporto
supporting wheel
roulette de support
Stützrolle
steunwiel
ruedas de soporte

attrezzabilità

easy to equip
possibilité d'équipement
Organisierbarkeit
gemakkelijk uit te rusten
que se puede equipar

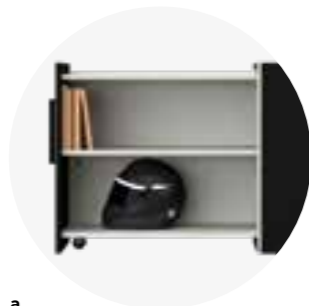

a.

vertical file DX o SX

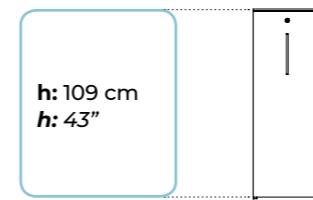

h: 109 cm
h: 43"

d: 40 cm
d: 15 3/4"

w: 80 cm
w: 31 1/2"



vaschetta porta cancelleria
stationery tray
plumier
Utensilienschale
bak voor benodigdheden
bandeja para papeleria



ruota regolabile
adjusting wheel
roulette réglable
Drehrolle
verstelbaar wiel
rueda regulable



chiusura soft di serie
soft closing as standard
fermeture amortie en standard
Serienmässige Anschlagdämpfer
standaard sluiting soft
cerrada soft de serie

attrezzabilità

easy to equip
possibilité d'équipement
Organisierbarkeit
gemakkelijk uit te rusten
que se puede equipar

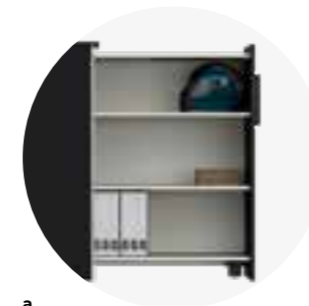

a.



b.

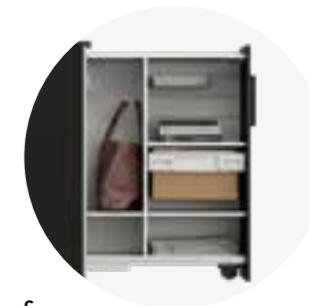

c.

mobile sottoscrivania ante battenti • support cabinets with wing doors • meuble sous bureau avec portes battantes • Stützsideboard mit Flügeltüren • meubel voor onder het bureau met deuren met scharnier • mueble de apoyo con puertas batientes



scocca e ripiano, structure and shelf, structure et étagère, Korpus und Einlegeboden, omhulsel en schap, estructura y estante

melaminico, melamine (laminated), mélamine, melamin, melamine, melamina



ante, doors, portes, Türen, deuren, puertas

melaminico, melamine (laminated), mélamine, melamin, melamine, melamina

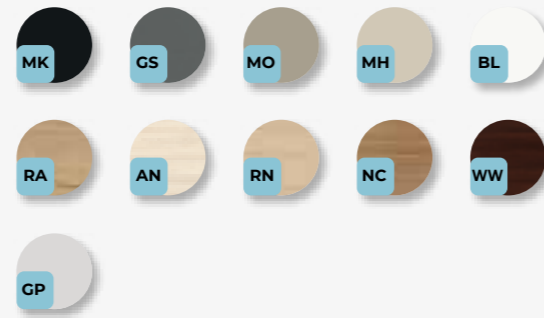

mobile sottoscrivania ante scorrevoli • support cabinets with sliding doors • meuble sous bureau avec portes coulissantes • Stützsideboard mit Schiebetüren • meubel voor onder het bureau met schuifdeuren • mueble de apoyo con puertas correderas



scocca, ripiani e tramezza; structure, shelves and partition; structure, étagères et cloisonette; Korpus, Einlegeböden und Unterteilung; omhulsel, schappen en tussenschot; estructura, estantes y tabique

melaminico, melamine (laminated), mélamine, melamin, melamine, melamina



***con ripiano MK**, *with MK shelf, *avec étagère MK, *mit Einlegeboden MK, *met MK-schap, *con estante MK

ante, doors, portes, Türen, deuren, puertas

melaminico, melamine (laminated), mélamine, melamin, melamine, melamina



maniglie in metallo, metal handles, poignées en métal, Metallgriffe, metalen handgrepen, tiradores metálicos



h: 68 cm
h: 26 3/4"

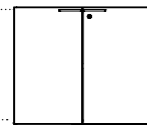

d: 40 cm
d: 15 3/4"

w: 80 cm
w: 31 1/2"

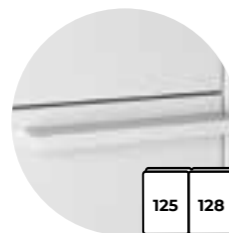
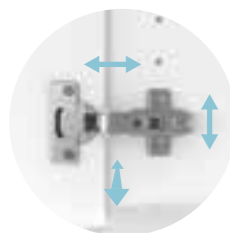

anta con cerniera regolabile montata
door with levelling hinge
porte avec charnière réglable montée
Tür mit montiertem einstellbarem Scharnier
deur met gemonteerd, verstelbaar scharnier
puerta con bisagra regulable montada

ripiano da 25 mm, 1"
25 mm, 1" shelf
étagère ép. 25 mm, 1"
25 mm, 1" starker Einlegeboden
schap van 25 mm, 1"
estante de 25 mm, 1"

maniglie
handles
poignées
Griffe
handgrepen
tiradores

h: 69-70,7* cm
h: 27"-27 3/4*"

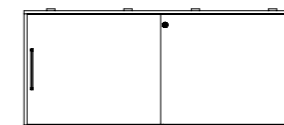
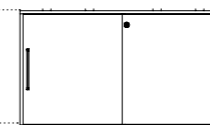

***only for Winglet**

d: 40 cm
d: 15 3/4"

w: 120 cm
w: 47 1/4"

w: 160 cm
w: 63"

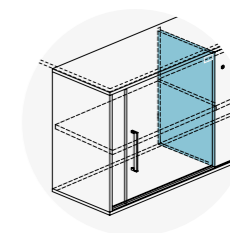
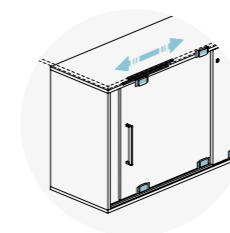

binario alluminio verniciato bianco
white painted aluminum rail
rails en métal laqué blanc
weiss lackierte Aluminiumschiene
witgelakte aluminium rail
binario aluminio pintado blanco

maniglia a presa continua
full grip handle
poignée avec prise continue
Griffleiste
doorlopende handgreep
tirador con agarre continuo

ante con soft open/close
doors with soft opening/closing
portes avec fermeture amortie
Türen mit Anschlagdämpfer
deuren met soft open/close
puertas con soft-system

tramezza centrale verticale
vertical central partition
cloison centrale verticale
Vertikale Korpus-Innenaufteilung
verticale, centrale middenwand
tabique central vertical

CADI.OP



finitura, finish, finition,
Oberfläche, afwerking, acabado

melaminico, melamine (laminata), mélamine,
melamin, melamine, melamina



top, top, top,
Abdeckplatte, bovenpaneel, tapa

melaminico, melamine (laminata), mélamine,
melamin, melamine, melamina



cassetti interni, internal drawer, tiroirs intérieurs,
Schubladenwannen, binnenlades, cajones interiores

metallo, metal, métal,
metall, metaal, metal

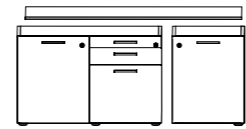

mobile da assemblare, to be fitted, meuble à assembler,
zerlegtes Möbel, te monteren meubel, mueble no montado

mobile di servizio DX o SX, service module Rh=Lh, elements de service Dr=Ga,
Multifunktionscontainer re=l, servicemeubels rechts=links, módulos de servicio dcho=izdo

h: 54 cm
h: 21 1/4"

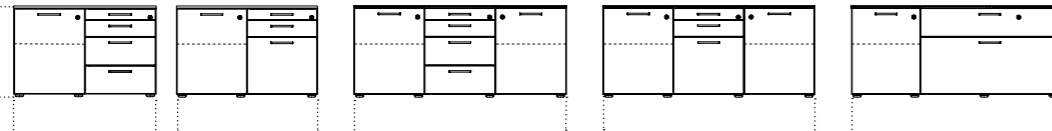

d: 56,2 cm
d: 22"

w: 83,6 cm
w: 33"

w: 125,3 cm
w: 49 1/4"



ruote (optional)
castors (optional)
roulottes (optionnelles)
Rollen (optional)
wielen (optioneel)
ruedas (opcional)



cassetto portacancelleria
stationery tray
bac tiroir
Utensilienauszug
lade voor benodigdheden
cajon para papeleria



separatori per cassetti metallici
separators for metal drawers
separateurs pour tiroirs métallique
scheiders voor metalen laden
separadores para cajones metalicos



fondo su classificatore
filing drawer bottom
fond pour tiroir extractible
Bodenplatte für Hängeauszug
bodem voor archieflade
fondo para cajon archivo

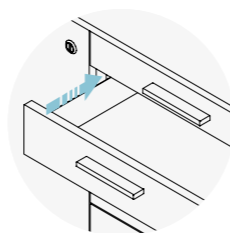

chiusura soft
soft closing
fermeture amortie
Anschlagsdämpfer
sluiting soft
cerrada soft

CADI.OP



finitura, finish, finition,
Oberfläche, afwerking, acabado

melaminico, melamine (laminata), mélamine,
melamin, melamine, melamina



top, top, top,
Abdeckplatte, bovenpaneel, tapa

melaminico, melamine (laminata), mélamine,
melamin, melamine, melamina



cassetti interni, internal drawer, tiroirs intérieurs,
Schubladenwannen, binnenlades, cajones interiores

metallo, metal, métal,
metall, metaal, metal

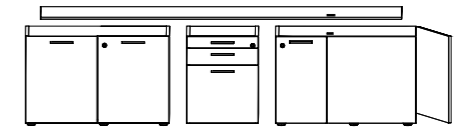

mobile da assemblare, to be fitted, meuble à assembler,
zerlegtes Möbel, te monteren meubel, Mueble no montado

mobile sottoscrivania DX o SX, support modules Rh=Lh, modules de soutien Dr=Ga,
Stützsideboard re=l, meubelen voor onder het bureau rechts=links, módulos de apoyo dcho=izdo

h: 54 cm
h: 21 1/4"



d: 56,2 cm
d: 22"

w: 167,2 cm
w: 65 3/4"

w: 208,9 cm
w: 82 1/4"

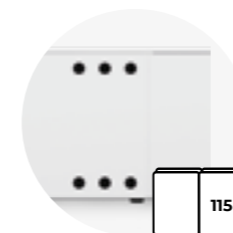

fori di aerazione su vano CPU
ventilation holes for CPU unit
trous d'aération sur module UC
Lüftungsschlitze im Containerhalter
ventilatiegaten op het CPU-compartiment
agujeros para ventilación sobre modulo CPU

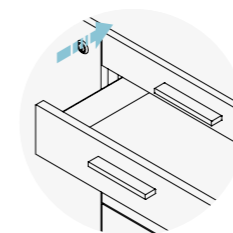

chiusura soft
soft closing
fermeture amortie
Anschlagsdämpfer
sluiting soft
cerrada soft



separatori per cassetti metallici
separators for metal drawers
separateurs pour tiroirs métallique
scheiders voor metalen laden
separadores para cajones metalicos



cassetto portacancelleria
stationery tray
bac tiroir
Utensilienauszug
lade voor benodigdheden
cajon para papeleria

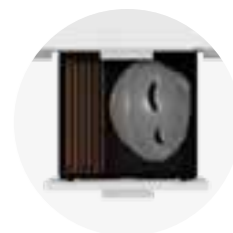

fondo su classificatore
filing drawer bottom
fond pour tiroir extractible
Bodenplatte für Hängeauszug
bodem voor archieflade
fondo para cajon archivo

CAD.IEX

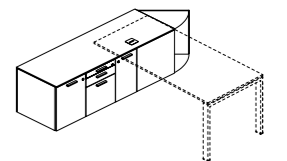
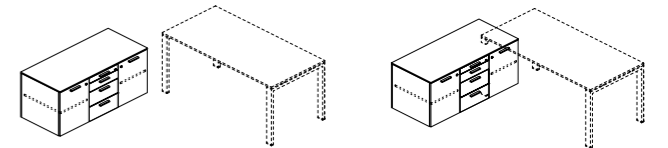
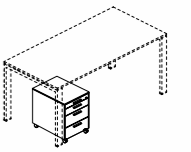

CADI.EX



fianchi, schiena, frontali e top; sides, back, frontals and top;
flancs, dos, façades et top; Seiten, Rückwand, Front und Abdeckplatte; Zijpanelen, achterkant, voorpanelen en bovenpaneel; costados, trasera, frontales y tapa

legno, wood, bois,
Holzfurnier, hout, madera

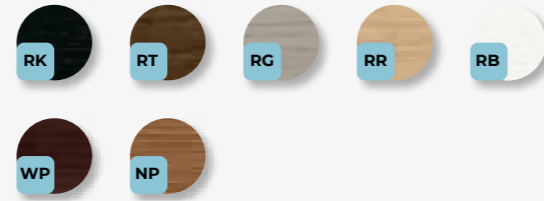

socca, structure, structure,
Korpus, omhulsel, estructura

melaminico, melamine (laminated), mélamine,
melamin, melamine, melamina



cassetti interni, internal drawer, tiroirs intérieurs,
Schubladenwannen, binnenlades, cajones interiores

metallo, metal, métal,
metall, metaal, metal



cassettiere, pedestals, caissons,
Container, ladenkasten, cajoneras

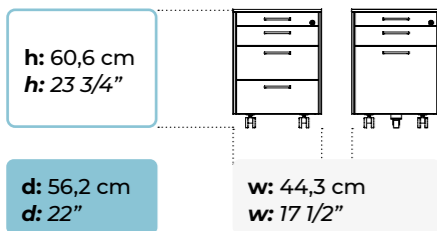

cassetto portacancelleria
stationery tray
bac tiroir
Utensilienauszug
lade voor benodigdheden
cajon para papeleria



separatori per cassetti metallici
separators for metal drawers
séparateurs pour tiroirs métallique
Trennblätter für Metallschubladen
scheiders voor metalen laden
separadores para cajones metalicos

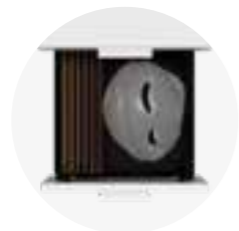

fondo su classificatore
filing drawer bottom
fond pour tiroir extractible
Bodenplatte für Hängeauszug
bodem voor archieflade
fondo para cajon archivo

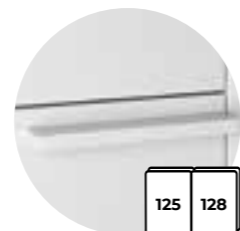

maniglie
handles
poignées
Griffe
handgrepen
tiradores

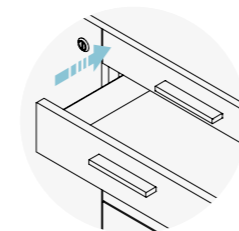

chiusura soft
soft closing
fermeture amortie
Anschlagsdämpfer
sluiting soft
cerrada soft

CADI.EX



fianchi, schiena, frontali e top; sides, back, frontals and top;
flancs, dos, façades et top; Seiten, Rückwand, Front und Abdeckplatte; Zijpanelen, achterkant, voorpanelen en bovenpaneel; costados, trasera, frontales y tapa

legno, wood, bois,
Holzfurnier, hout, madera

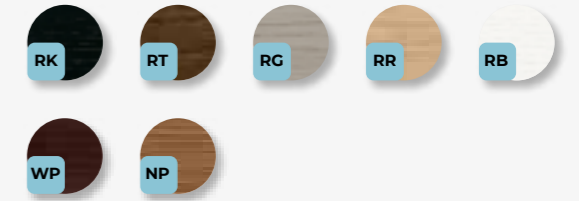

socca e ripiano, structure and shelf, structure et étagère, Korpus und Einlegeboden, omhulsel en schap, estructura y estantei

melaminico, melamine (laminated), mélamine, melamin, melamine, melamina



cassetti interni, internal drawer, tiroirs intérieurs, Schubladenwannen, binnenlades, cajones interiores

metallo, metal, métal, metall, metaal, metal

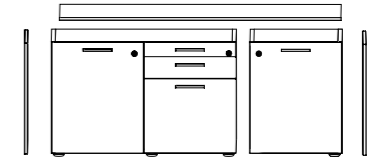

mobile da assemblare, to be fitted, meuble à assembler, zerlegtes Möbel, te monteren meubel, mueble no montado

mobile di servizio DX o SX, service module Rh=Lh, elements de service Dr=Ga,
Multifunktionscontainer re=li, servicemeubels rechts=links, módulos de servicio dcho=izdo

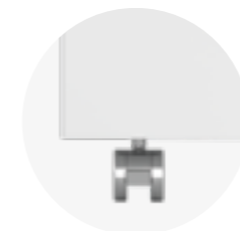
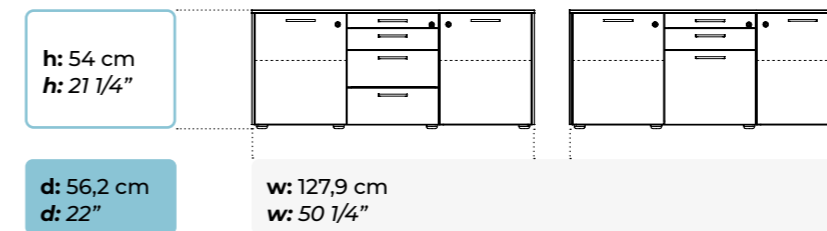

ruote (optional)
castors (optional)
roulettes (optionnelles)
Rollen (optional)
wielen (optioneel)
ruedas (opcional)



cassetto portacancelleria
stationery tray
bac tiroir
Utensilienauszug
lade voor benodigdheden
cajon para papeleria



separatori per cassetti metallici
separators for metal drawers
séparateurs pour tiroirs métallique
Trennblätter für Metallschubladen
scheiders voor metalen laden
separadores para cajones metalicos

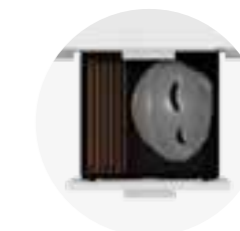

fondo su classificatore
filing drawer bottom
fond pour tiroir extractible
Bodenplatte für Hängeauszug
bodem voor archieflade
fondo para cajon archivo

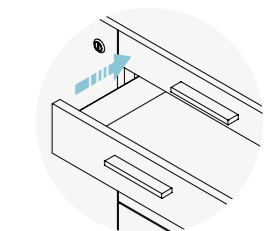

chiusura soft
soft closing
fermeture amortie
Anschlagsdämpfer
sluiting soft
cerrada soft



fianchi, schiena, ante e top; sides, back, doors and top;
flancs, dos, doors et top; Seiten, Rückwand, Türen und Abdeckplatte; Zijpanelen, achterkant, deuren en bovenpaneel; costados, trasera, puertas y tapa

Legno, wood, bois,
Holzfurnier, hout, madera

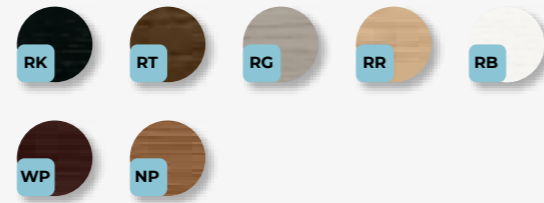

socca e ripiano, structure and shelf, structure et étagère, Korpus und Einlegeboden, omhulsel en schap, estructura y estantei

melaminico, melamine (laminated), mélamine, melamin, melamine, melamina



cassetti interni, internal drawer, tiroirs intérieurs, Schubladenwannen, binnenlades, cajones interiores

metallo, metal, métal, metall, metaal, metal

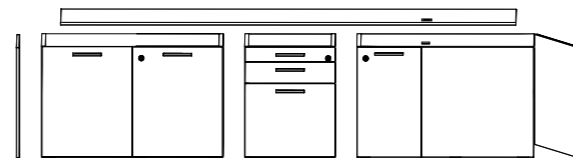

mobile da assemblare, to be fitted, meuble à assembler, zerlegtes Möbel, te monteren meubel, mueble no montado

mobile sottoscrivania DX o SX, support modules Rh=Lh, modules de soutien Dr=Ga, Stützsideboard re=li, meubelen voor onder het bureau rechts=links, módulos de apoyo dcho=izdo

h: 54 cm
h: 21 1/4"

d: 56,2 cm
d: 22"

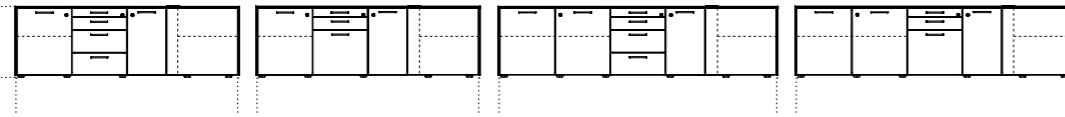

w: 167,9 cm
w: 66"

w: 209,6 cm
w: 82 1/2"



cassetto portacancellaria
stationery tray
bac tiroir
Utensilienauszug
lade voor benodigdheden
cajon para papeleria



separatori per cassetti metallici
separators for metal drawers
separateurs pour tiroirs métallique
Trennblätter für Metallschubladen
scheiders voor metalen laden
separadores para cajones metalicos



fondo su classificatore
filing drawer bottom
fond pour tiroir extractible
Bodenplatte für Hängeauszug
bodem voor archieflade
fondo para cajon archivo



fori di aerazione su vano CPU
ventilation holes for CPU unit
trous d'aération sur module UC
Lüftungsschlitze im Containerhalter
ventilatiegaten op het CPU-compartiment
agujeros para ventilacion sobre modulo CPU

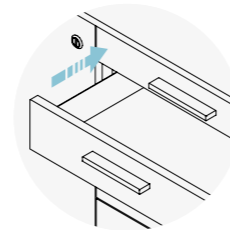

chiusura soft
soft closing
fermeture amortie
Anschlagsdämpfer
sluiting soft
cerrada soft

elettrificazione, electrification, électrification,
Elektrifikation, elektrificatie, electrificación

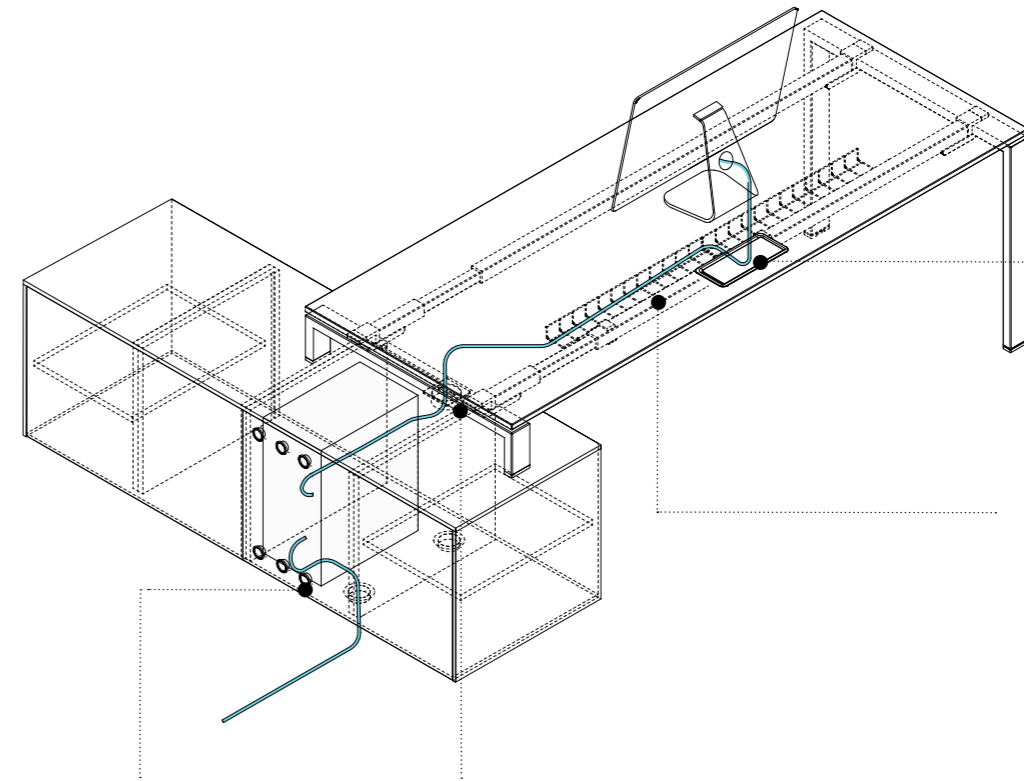

top access
top access
accès supérieur
Top-Zugang
bovenpaneel toegang
acceso superior

cestello passacavi
cables holder baskets
bac porte-cables
Kabelwanne
mand voor kabeldoorgang
cesto pasacables

fori di aerazione su vano CPU
ventilation holes for CPU unit
trous d'aération sur module UC
Lüftungsschlitze im Containerhalter
ventilatiegaten op het CPU-compartiment
agujeros para ventilacion sobre modulo CPU

tappo passacavi quadrato
square cable access port
couchon passe-cable carré
quadratischer Kabeldurchlass
vierkante dop kabeldoorgang
tapon pasacables cuadrado



METAL

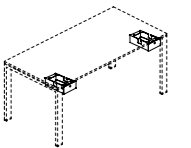
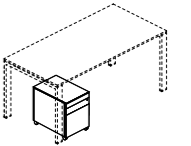

cassettiere metalliche • metal pedetals • caissons métalliques • Metall-Container • metalen ladenkasten • cajoneras metálicas



finitura, finish, finition, Oberfläche, afwerking, acabado

metallo, metal, métal, metall, metaal, metal

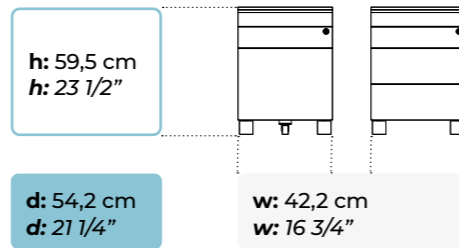
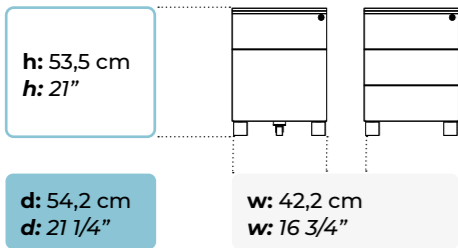

Cassettino sottocrivania • drawer under desk • tiroir sous le bureau • Schublade unter Schreibtisch • lade onder desk • cajón de debajo del escritorio



finitura, finish, finition, Oberfläche, afwerking, acabado

metallo, metal, métal, metall, metaal, metal

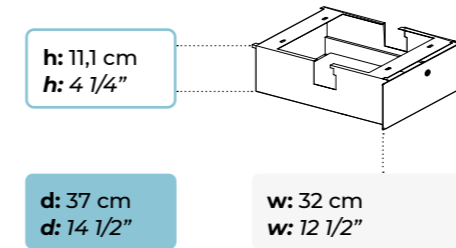
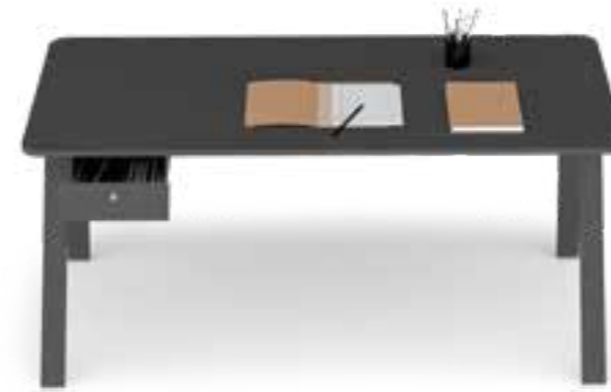

sistema antiribaltamento
anti-tilt system
système anti-basculement
Kippsicherung
kantelbeveiligingssysteem
sistema anti vuelco



cassetto portacancelleria
stationery tray
bac tiroir
Utensilienauszug
lade voor benodigdheden
cajon para papeleria



vaschetta porta cancelleria
stationery tray
plumier
Utensilienschale
bak voor benodigdheden
bandeja para papeleria



separatori per cassetti metallici
separators for metal drawers
séparateurs pour tiroirs métallique
Trennblätter für Metallschubladen
scheiders voor metalen laden
separadores para cajones metálicos

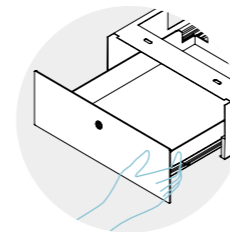

presa laterale
side socket
prise latérale
seitlicher Griff
zijgreep
toma lateral

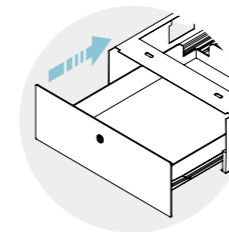

chiusura soft
soft closing
fermeture amortie
Anschlagsdämpfer
sluiting soft
cerrada soft



vaschetta porta cancelleria
stationery tray
plumier
Utensilienschale
bak voor benodigdheden
bandeja para papeleria



cassettino interno alla gamba
inner leg small drawer
tiroir interne au pied
Einzelschub, innenseitig
lade in de poot
cajon interior a la pata



cassettino esterno alla gamba
outer leg small drawer
tiroir externe au pied
Einzelschub, aussenseitig
lade buiten de poot
cajon exterior a la pata

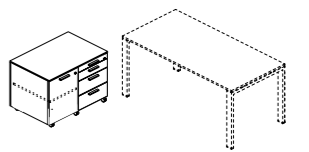
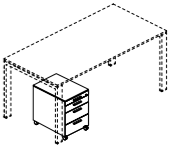

EKO



finitura, finish, finition,
Oberfläche, afwerking, acabado

melaminico, melamine (lamine), mélamine,
melamin, melamine, melamina



cassetti interni, internal drawer, tiroirs intérieurs,
Schubladenwannen, binnenlades, cajones interiores

melaminico, melamine (lamine), mélamine,
melamin, melamine, melamina



cassettiere, pedestals, caissons,
Container, ladenkasten, cajoneras

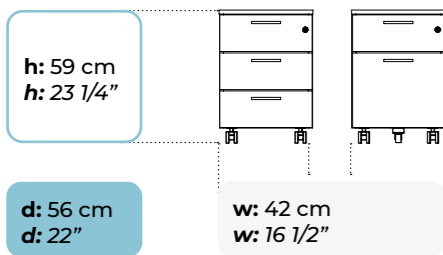

sistema antiribaltamento
anti-tilt system
système anti-basculément
Kippsicherung
kantelbeveiligingssysteem
sistema anti vuelco



vaschetta porta cancelleria
stationery tray
plumier
Utensilienschale
bak voor benodigdheden
bandeja para papelería

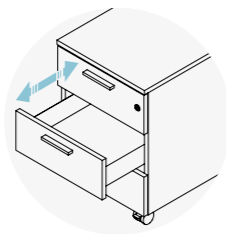

chiusura soft optional
soft closing as optional
fermeture amortie en option
optionale Anschlagdämpfer
optionele sluiting soft
cerrada soft opcional

CADI.OP EKO



finitura, finish, finition,
Oberfläche, afwerking, acabado

melaminico, melamine (lamine), mélamine,
melamin, melamine, melamina

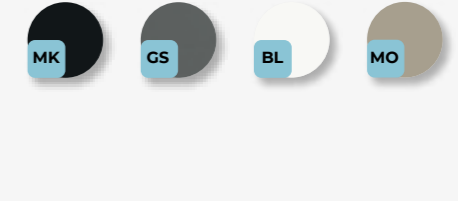

cassetti interni, internal drawer, tiroirs intérieurs,
Schubladenwannen, binnenlades, cajones interiores

melaminico, melamine (lamine), mélamine,
melamin, melamine, melamina

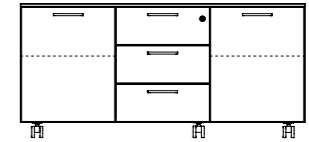

mobile consegnato montato, fitted piece, meuble livré démonté,
Das Möbel wird montiert geliefert, meubel gemonteerd geleverd,
mueble entregado montado

mobile di servizio DX o SX, service module Rh=Lh, elements de service Dr=Ga,
Multifunktionscontainer re=li, servicemeubels rechts=links, módulos de servicio dcho=izdo

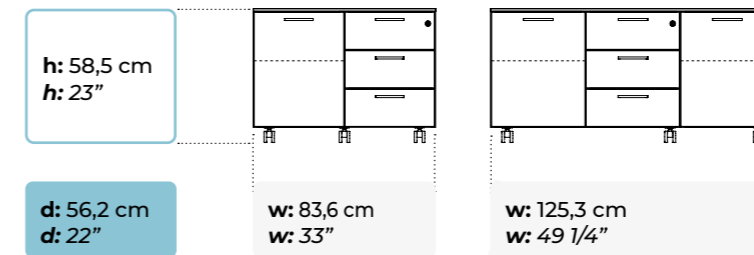

vaschetta porta cancelleria
stationery tray
plumier
Utensilienschale
bak voor benodigdheden
bandeja para papelería

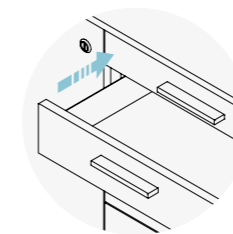

chiusura soft optional
soft closing as optional
fermeture amortie en option
optionale Anschlagdämpfer
optionele sluiting soft
cerrada soft opcional



126

maniglie • handles • poignées •
Griffe • handgrepen • manijas



127

chiavi • keys • clés •
Schlüssels • sleutels • llaves

plastica, plastic, plastique,
Plastik, kunststof, plástico

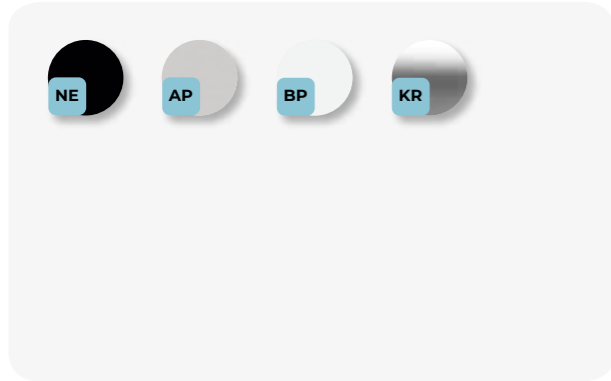

laccato opaco, matt lacquered, lacqué mat,
matt lackiert, mat gelakt, laqueado mate

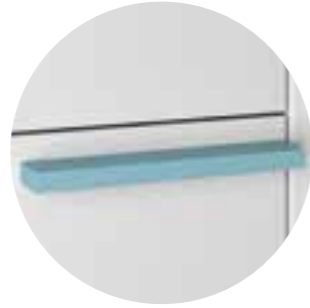

legno, wood, bois,
Holzfurnier, hout, maderá

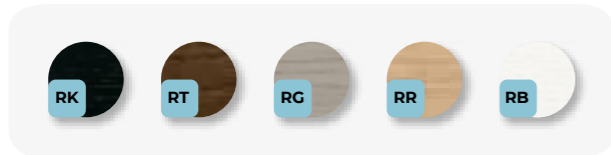

metallo, metal, métal,
metall, metaal, metal

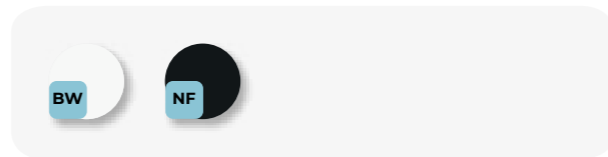

sistemi di apertura • opening system • systèmes d'ouvertures •
Öffnungssysteme • openingssystemen • sistema de apertura

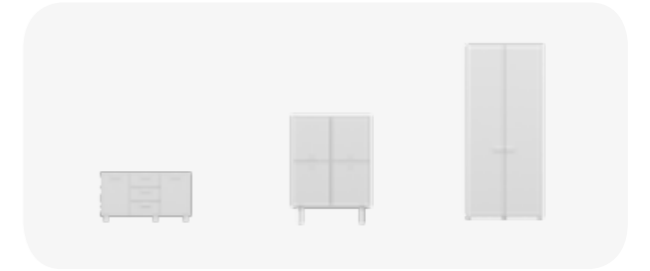
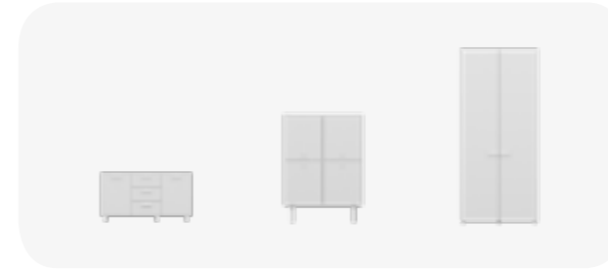

office a

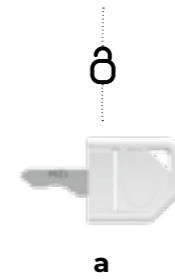

office b

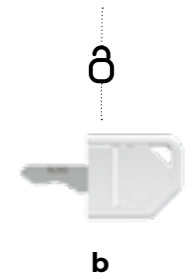

cifratura unica, unique encryption, cryptage unique,
Gleichschliessende Schlösser, één combinatie, cifrado unico

cifratura unica, unique encryption, cryptage unique,
Gleichschliessende Schlösser, één combinatie, cifrado unico

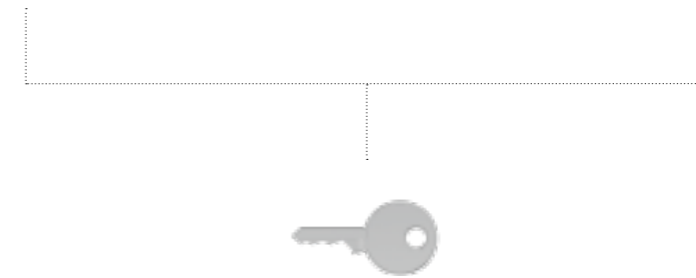

chiave passpartout, key passepartout, clé passepartout,
Generalschlüssel, passepartoutsleutel, llave passepartout



codice di identificazione chiave/serratura
key/lock identification code
code d'identification clé/serrure
Identifikationscodes Schlüssel/Schloss
identificatiecode sleutel/slot
codigo de identificacion llave/cerradura



chiave di servizio per estrazione nottolino
service key for pawl extraction
clé d'extraction pour barillet
Werkzeugschlüssel zum Zylinder Ausbau
servicesleutel voor extractie pal
llave de servicio para extracción del trinchete





legno • wood • bois •
Holzfurnier • hout • madera

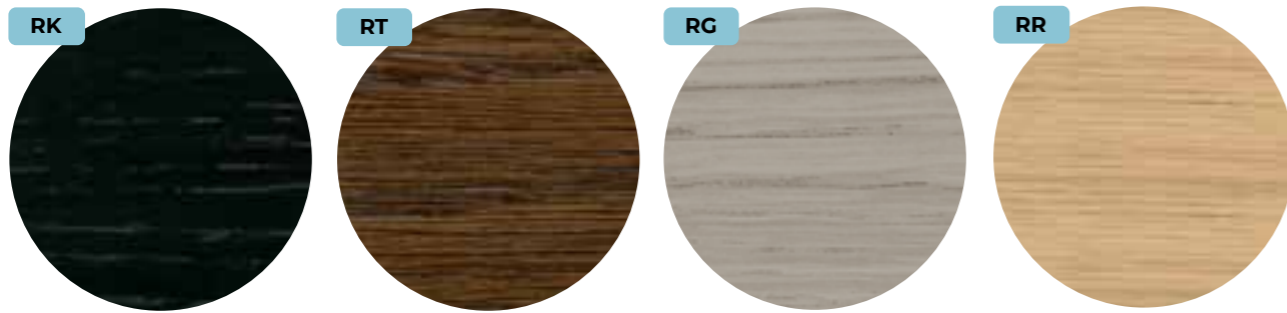

rovere laccato nero, black lacquered oak, chène laqué noir, schwarz lackierter eiche, zwart gelakt eiken, roble lacado negro

rovere tabacco, tobacco oak, chène tabac, eiche tabak, eikenhout tabak, roble tabaco

rovere grigio, grey oak, chène gris, eiche grau, grijs eiken, roble gris

rovere naturale, natural oak, chène naturel, natur eiche, eikenhout natuur, roble natural



rovere laccato bianco, white lacquered oak, chène laqué blanc, weiß lackierter eiche, wit gelakt eiken, roble lacado blanco

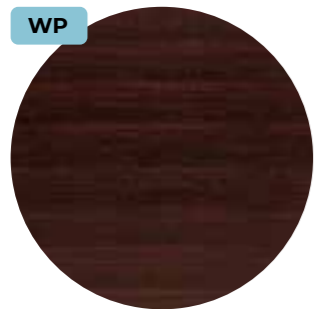

wengé, wengé, wengé, wengé, wengé, wengé

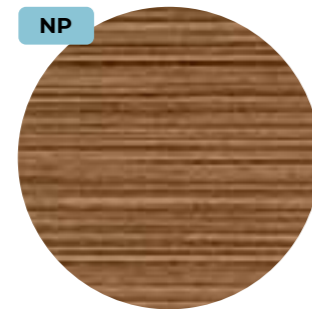

noce americano, american walnut, noyer américain, amerikanischer nussbaum, amerikaans notenhout, nogal americano

melaminico • melamine (laminated) • mélamine •
melamin • melamine • melamina

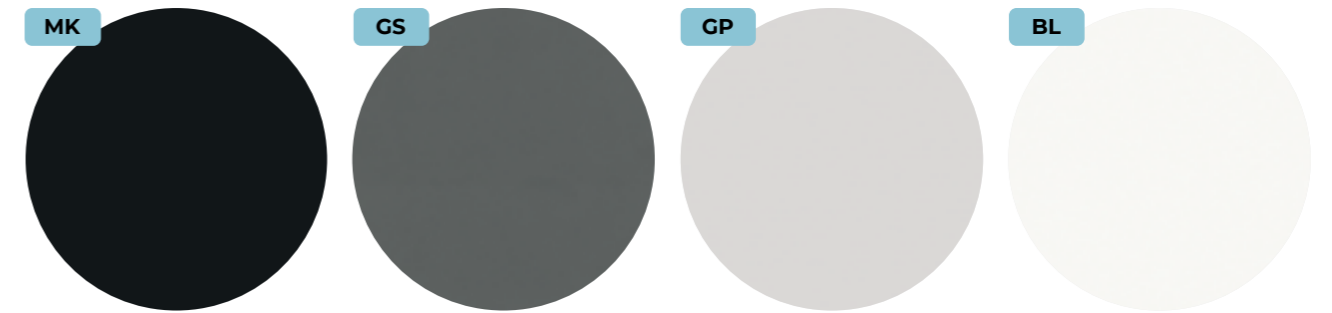

nero, black, noir, schwarz, zwart, negro

grigio granito, granite grey, gris granit, granitgrau, granietgrijs, gris granito

grigio perla, pearl grey, gris perle, perlgau, parelgrijs, gris perla

bianco, white, blanc, weiß, wit, bianco

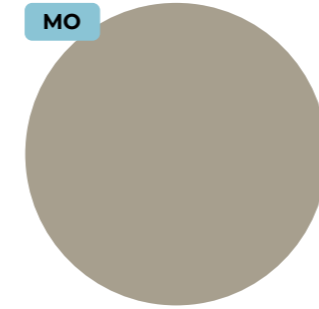

tortora, turtledove, tourterelle, turteltaube, tortelduif, tórtola

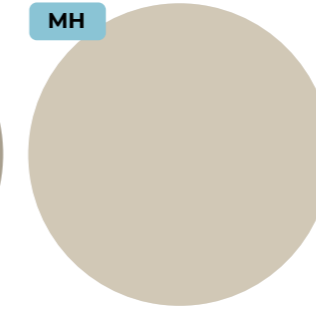

nebbia, mist, brouillard, nebelgrau, mist, niebla

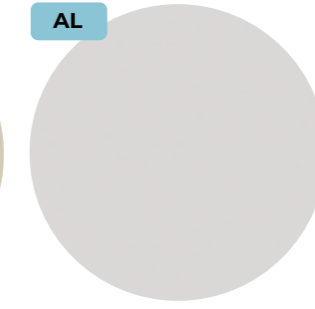

alluminio, aluminium, aluminium, aluminium, aluminium, aluminio



wengé, wengé, wengé, wengé, wengé, wengé

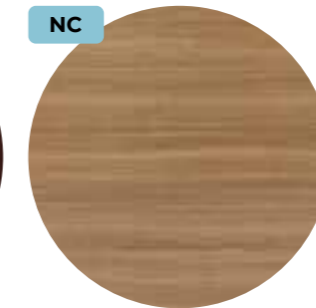

noce canaletto, canaletto walnut, noyer canaletto, canaletto nussbaum, notenhout canaletto, nogal canaletto

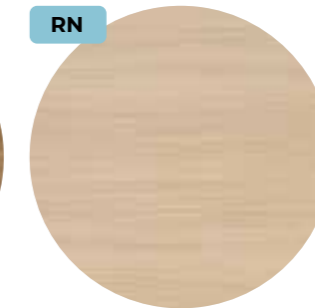

rovere naturale, natural oak, chène naturel, nature eiche, eikenhout natuur, roble natural



rovere anticato, traditional oak, chène antique, eiche antik, oud eiken decormelamine, melamina roble antiguo

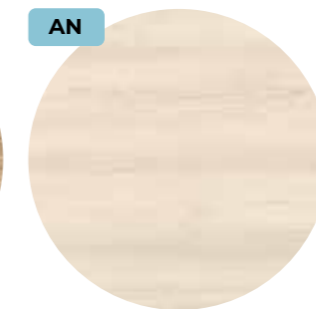

acero champagne, champagne hard maple, érable champagne, champagner-ahorn, esdoorn champagne, arce champán

vetro temperato opaco • tempered matt glass ·
verre trempé opaque · matt temperiertes glas ·
mat gehard glas · vidrio templado mate

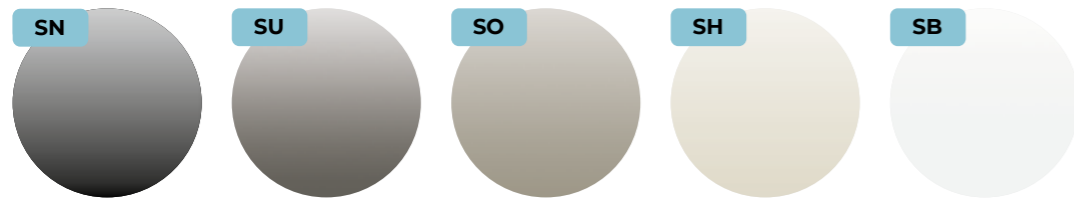

nero
black
noir
schwarz
zwart
negro

titanio
titanium
titane
titan
titanium
titanio

tortora
turtledove
tourterelle
turteltaube
tortelduif
törtola

nebbia
mist
brouillard
nebelgrau
mist
niebla

bianco
white
blanc
weiß
wit
blanco

vetro temperato • tempered glass ·
verre trempé · temperiertes glas ·
gehard glas · vidrio templado

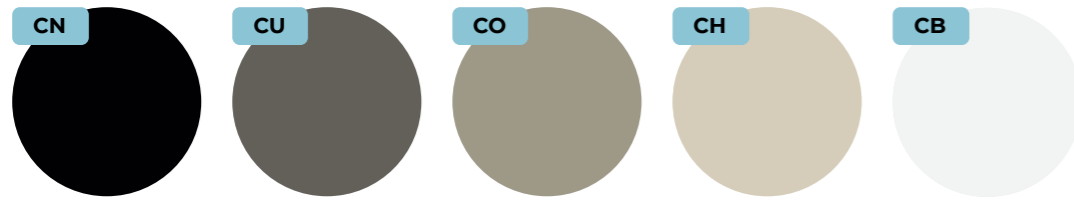

nero
black
noir
schwarz
zwart
negro

titanio
titanium
titane
titan
titanium
titanio

tortora
turtledove
tourterelle
turteltaube
tortelduif
törtola

nebbia
mist
brouillard
nebelgrau
mist
niebla

bianco
white
blanc
weiß
wit
blanco

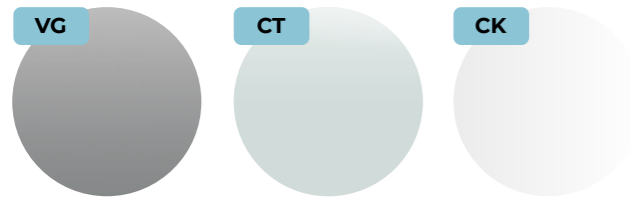

grigio sp. 5mm
grey sp. 5 mm
gris sp. 5 mm
grau sp. 5 mm
grijs sp. 5 mm
gris sp. 5 mm

satinato
frosted
satiné
mattier
gesatineers
satinado

trasparente
transparent
transparent
transparentes
transparente
transparente

plastica • plastic ·
plastique · Plastik ·
Kunststof · plástico

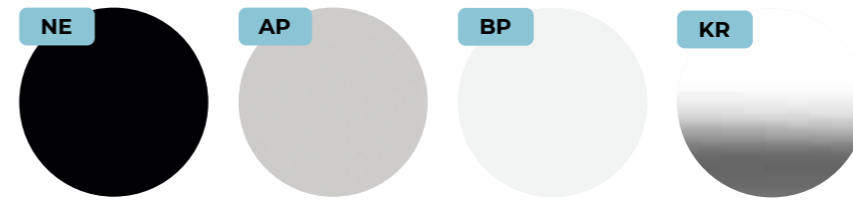

colore nero
black-painted
noir
farbe schwarz
zwarte kleur
color negro

colore alluminio
silver-painted
aluminium
farbe aluminium
aluminium kleur
color aluminio

colore bianco
white-painted
blanc
farbe weiß
wit kleur
color blanco

cromo lucido
glossy chrome
chrome brillant
chrom poliert
glazend verchromd
cromo pulido

metallo • metal ·
métal · metall ·
metaal · metal

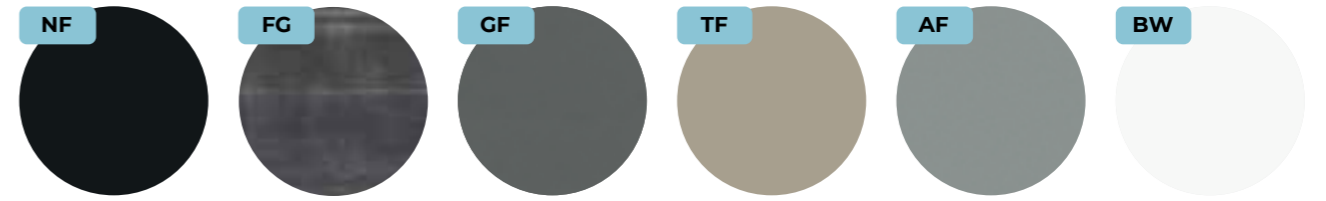

nero
black
noir
schwarz
zwart
negro

metallo crudo
raw metal
métal brut
rohes metall
onbehandeld metaal
metal tosco

grigio granito
granite grey
gris granit
granitgrau
granietgrijs
gris granito

tortora
turtledove
tourterelle
turteltaube
tortelduif
törtola

epox alluminio
silver epoxy
epoxy aluminium
aluminium
aluminiumkler geepoxerd
epoxidica de aluminio

bianco
white
blanc
weiß
wit
blanco

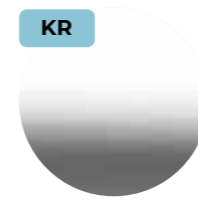

cromo lucido
glossy chrome
chrome brillant
chrom poliert
glazend verchromd
cromo pulido

laccato opaco • matt lacquered •
lacqué mat • matt lackiert •
mat gelakt • laqueado mate

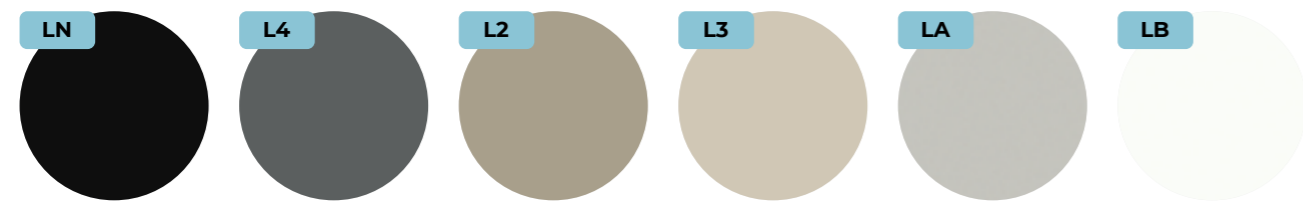

nero
black
noir
schwarz
zwart
negro

titanio
titanium
titane
titan
titanium
titanio

tortora
turtledove
tourterelle
turteltaube
tortelduif
tòrtola

nebbia
mist
brouillard
nebelgrau
mist
niebla

alluminio
aluminium
aluminium
aluminium
aluminium
aluminio

bianco
white
blanc
weiß
wit
bianco

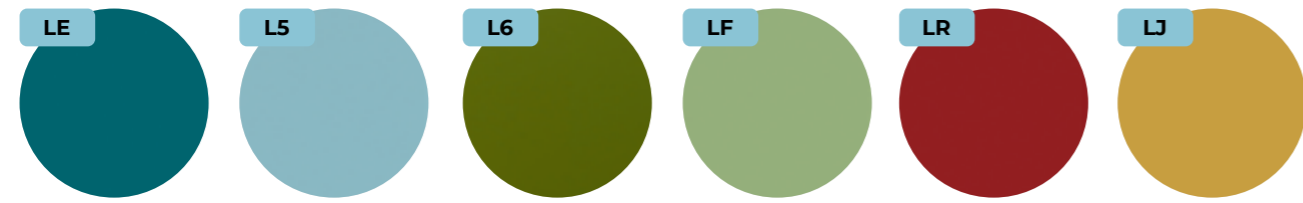

deep teal
deep teal
bleu canard
deep teal
deep teal
deep teal

oceano
ocean
océan
meerblau
ocean
oceano

verde muschio
moss green
vert mousse
moosgrün
mosgroen
verde musgo

verde natura
grass green
vert nature
grasgrün
groene natuur
verde naturaleza

bordeaux
bordeaux
bordeaux
bordeaux
bordeaux
burdeos

giallo gold
yellow gold
jaune or
goldgelb
geelgouden
oro amarillo

metacrilato • methacrylate •
méthacrylate • Methacrylat •
methacrylaat • metacrilato



nero opaco
black matt
noir mat
schwarz matt
zwart mat
negro mate

grigio
grey
gris
grau
grijs
gris

bianco opaco
white matt
blanc mat
weiss matt
wit mat
brillo mate

tessuto • fabric • tissu •
Stoff • stof • tejido

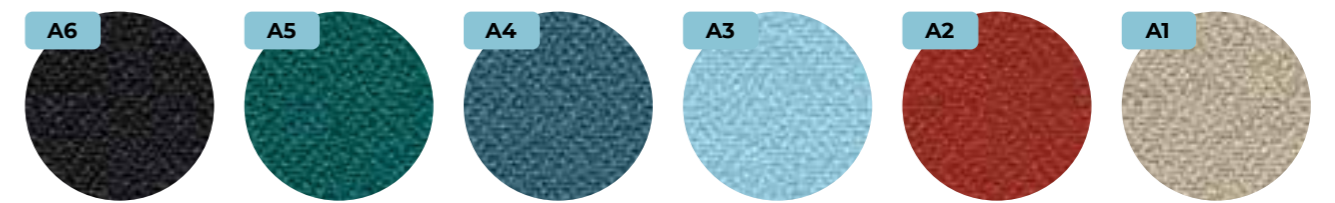

CAMIRA-LUCIA
testa di moro-sombrero
dark brown-sombrero
brun gris-sombrero
dunkelbraun-sombrero
donkerbruin-sombrero
pardo grisàrceo-sombrero

CAMIRA-LUCIA
petrolio-windjammer
petroleum-windjammer
pétrole-windjammer
ptroleum blau-windjammer
petroleum-windjammer
pètròle-windjammer

CAMIRA-LUCIA
blu-martinique
blue-martinique
bleu-martinique
blau-martinique
blauw-martinique
azul-martinique

CAMIRA-LUCIA
celeste-arecibo
light blue-arecibo
bleu-arecibo
hellblau-arecibo
hemelsblau-arecibo
azul celeste-arecibo

CAMIRA-LUCIA
mattone-jamaica
brick-coloured jamaica
brique-jamaica
ziegelrot-jamaica
baksteen-jamaica
pardo cobre-jamaica

CAMIRA-LUCIA
sabbia-aruba
sable-aruba
sable-aruba
sandfarbe
zand-aruba
arena-aruba

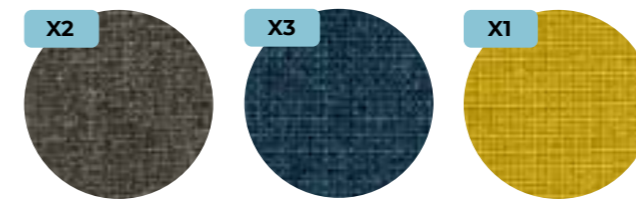

GABRIEL-XPRESS
verde sottobosco
underwood green
vert sous-bois
unterholz-groen
bosgrond-groen
verdes-sootoboscque

GABRIEL-XPRESS
blue jeans
blue jeans
blue jeans
denim blue
jeans blauw
azul denim

GABRIEL-XPRESS
giallo primavera
spring yellow
jaune printemps
frühling gelb
lentegeel
amarillo primavera

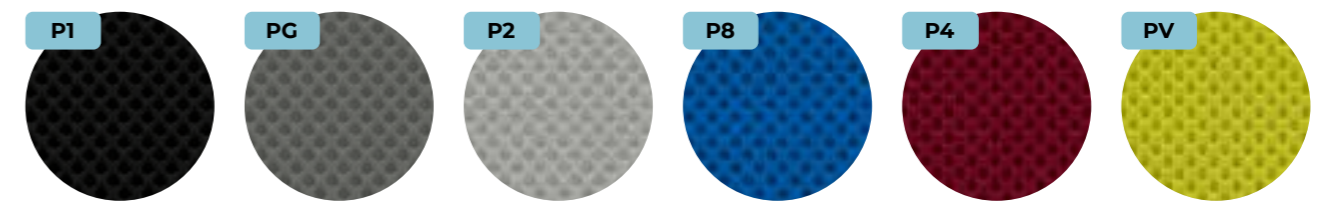

PUMA
nero
black
noir
schwarz
zwart
negro

PUMA
grigio scuro
dark grey
gris foncé
dunkelgrau
gewoon grijs
gris hormigòn

PUMA
grigio medio
medium grey
gris moyen
mittlgrau
gewoon grijs
gris hormgòn

PUMA
blu
dark blue
bleu
blau
blauw
azul

PUMA
bordeaux
bordeaux
bordeaux
bordeaux
bordeaux
burdeos

PUMA
verde mela
apple green
vert pomme
apfelgrün
applegroen
verde manzana



selezione delle materie prime • selection of raw materials • sélection des matières premières • Auswahl der Baumaterialien • selectie van grondstoffen • seleccion de materias primas

attenzione e cura nella scelta dei materiali: Legno impiallacciato / vetro / pelle / tessuto / vitro ceramica / Fenix • attention and care in the selection of materials: Wood veneer / glass / leather / fabric / vitro ceramic / Fenix • attention et soin dans la sélection des matériaux: bois plaquage/verre/peau/tissu/vitro-céramique/Fenix • Aufmerksamkeit und Sorgfalt der der Auswahl der Materialien: Holzfurnier / Glas / Leder / Stoff / Glaskeramik / Fenix • aandacht en zorg in de keuze van materialen: Houtfineer / glas / leder / stof / keramisch glas / Fenix • atención y cuidado en la selección de los materiales: madera pintada/ vidrio/piel/tejido/vidrio ceramica/Fenix



produzione certificata, ecologica e rispettosa dell'ambiente e dell'utente • certified production, green environmentally and user friendly • production certifiée, écologique et respectueuse de l'environnement et de l'individu • Zertifizierte, umweltfreundliche Produktion mit großer Achtung für Umwelt und Nutzer • gecertificeerde productie, ecologische productie met respect voor het milieu en de gebruiker • producción certificada, ecologica y respetuosa del ambiente y del usuario

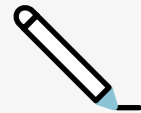

progettazioni • plannings • projets • Projekte • ontwerpen • proyectos



capacità di produzione industriale • industrial production ability • capacité de production industrielle • Industrielle Fertigungskapazität • industrielle productiecapaciteit • capacidad de producción industrial



garanzia e disponibilità dei componenti • warranty and availability of components • garantie et disponibilité des composants • Garantie und Verfügbarkeit der Komponenten • garantie en beschikbaarheid van onderdelen • garantía y disponibilidad de los componentes



esperienza • experience • expérience • Erfahrung • ervaring • experiencia



articoli speciali • special items • articles spéciaux • Sonderanfertigungen • speciale items • artículos especiales

il nostro sistema di produzione segue standard avanzati per la cura dell'individuo e della natura • our production system follows advanced standards for individual and nature care • notre système de production suit des standards avancées dans le soin de l'individu et de la nature • Unser Produktionsverfahren richtet sich nach fortschrittlichen Standards zum Schutz von Mensch und Natur • ons productiesysteem volgt geavanceerde normen met respect voor de persoon en de natuur • Nuestro sistema de producción sigue estandard avanzados para el cuidado al individuo y a la naturaleza



California 93120
Compliant for Formaldehyde Phase 2



The mark of responsible forestry

I nostri prodotti in melaminico possono essere forniti FSC® su richiesta cliente • Our melamine products can be FSC® supplied upon customer request • Nos produits en mélaminé peuvent être fournis certifiés FSC® sur demande du client • Unsere Melamin-Produkte können auf Anfrage des Kunden in FSC® geliefert werden • Onze melamineproducten kunnen op verzoek van de klant FSC® worden geleverd • Nuestros productos de melamina pueden ser suministrados FSC® a petición del cliente

la nostra azienda opera con l'obiettivo primario di garantire prodotti che raggiungano un corretto equilibrio tra sostenibilità ambientale e design • our Company operates with the primary objective of guaranteeing products that achieve a correct balance between, environmental sustainability and design • notre société a comme objectif principal celui de garantir des produits qui atteignent un juste équilibre entre, durabilité environnementale et design • Unser Unternehmen hat sich als Hauptziel die Garantie von Produkten gesetzt, welche ein korrektes Gleichgewicht zwischen Umweltverträglichkeit und Design erzielen • ons bedrijf beoogt de garantie van producten die een juist evenwicht bereiken tussen milieuduurzaamheid en ontwerp • nuestra empresa trabaja con el objetivo primario de garantizar productos que alcanzan un correcto equilibrio entre sostenibilidad ambiental y de diseño



imballi costituiti da materiali facilmente separabili e riciclabili • recyclable and easy to dispose packagings • emballages constitués par matériaux facilement séparables et recyclables • Die Verpackungen ermöglichen ein schnelles Trennen und Recyclen von Materialien • verpakkingen uit gemakkelijk scheidbaar en recycleerbaar materiaal • embalaje constituido de materiales simplemente separables y reciclables



TSCA Title VI
Compliant

riduzione di formaldeide e di sostanze tossiche e potenzialmente dannose • low formaldehyde emission, low toxic and potentially harmful substances • réduction de formaldéhyde et des substances toxiques et potentiellement nocives • Reduzierung von Formaldehyd und Giftstoffe, die eine potentielle Gefahr darstellen • gereduceerd gebruik van formaldehyde en andere giftige en mogelijk schadelijke stoffen • reducción de formaldehido y sustancias tóxicas y que pueden ser dañinas



estensione del ciclo di vita dei prodotti • product life extension • extension du cycle de vie du produit • Ausdehnung der Produkt-Lebenserwartung • Verlenging van de levenscyclus van de producten • extensión del ciclo de vida de los productos



produzione di arredi a ridotto impatto ambientale • furniture products with reduced environmental impact • production de mobilier à impact environnemental réduit • Produktion von Einrichtungen mit niedriger Umweltbelastung • productie van meubels met een gereduceerde milieu-impact • producción de mobiliario con reducido impacto ambiental



facilità di disassemblaggio per favorire la riconfigurabilità, il riutilizzo o il riciclo • easy K/D to promote reconfiguration, reuse or recycling • simplicité de démontage pour favoriser la reconfiguration, la réutilisation ou le recyclage • Leichte Zerlegung um Neukombination, Wiederverwendung oder Recyclen zu ermöglichen • gemakkelijke demontage die herconfiguratie, hergebruik of recycling ten goede komt • facilidad de desensamblaje para facilitar el configurar de nuevo, reutilizar y reciclar

Edizione Gennaio 2020 - Particolari tecnici ed estetici possono essere modificati senza preavviso. Le rese cromatiche non sono vincolanti così come la fedeltà della riproduzione. Dati, misure e dettagli devono essere verificati con il listino.

January 2020 edition - Technical and aesthetic details can be modified without notice. Colour rendering may differ. Check the data, measures and details on the price list.

Édition janvier 2020 - Les détails techniques et esthétiques peuvent être modifiés sans préavis. Le rendu chromatique n'est pas contractuel, ainsi que la fidélité de la reproduction. Les données, les mesures et les détails doivent être vérifiés avec le tarif.

Ausgabe Januar 2020 - Technische und ästhetische Details könnten ohne Vorankündigung geändert werden. Die Echtheit der Farbwiedergabe ist nicht verbindlich. Daten, Maße und Details sind in der Preisliste zu überprüfen.

Uitgave Januori 2020 - Technische en esthetische details kunnen zonder voorafgaande kennisgeving gewijzigd worden. De kleuren zijn niet bindend, net als de nauwkeurigheid van de reproductie. Gegevens, afmetingen en details moeten gecontroleerd worden met de lijst.

Edición de enero de 2020 - Los detalles técnicos y estéticos pueden ser modificados sin preaviso. Los rendimientos de color y la fidelidad de la reproducción no son vinculantes. Los datos, las medidas y los detalles deben ser verificados con la tarifa.

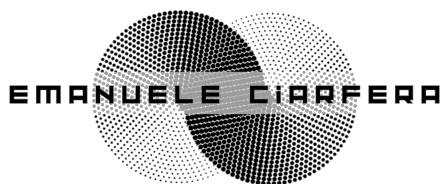

bralco

Arkki

graphic design: gherardi architetti
images: gherardi architetti, hed digital

*thanks to: Arper, ICF, FontanaArte, Davide Groppi,
Vibia, Zumtobel, Materium, Vitra
printed: grafiche antiga*

Bralco - Via Luigi Einaudi 1, 31058 Susegana TV - Italy
T +39 0438 437 711
info@bralco.it - www.bralco.it



