

bralco

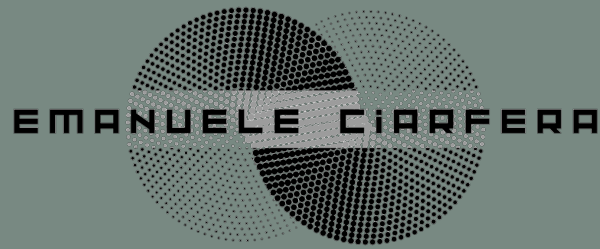

glider . loopy . take-off

S18

design:
Gianantonio Perin
Giorgio Topan

**Glider, Loopy e Take-Off. Tre espressioni di design,
tre modi di vivere l'ufficio operativo moderno.**

Glider, Loopy and Take-Off. Three design lines,
three ways of experiencing the modern office.

Glider, Loopy et Take-Off. Trois expressions de design,
trois façons de découvrir le bureau opérationnel moderne.

Glider, Loopy und Take-Off. Drei Designausdrücke,
drei Möglichkeiten, das moderne operative Büro zu erleben.

Glider, Loopy y Take-Off. Tres expresiones de diseño,
tres formas de vivir la oficina operativa moderna.







Glider



Armonia, integrazione e flessibilità. Loopy è un sistema che arricchisce l'ufficio contemporaneo.

Harmony, integration and flexibility. Loopy enriches the contemporary office.

Harmonie, intégration et flexibilité. Loopy est un système qui enrichit le bureau contemporain.

Harmonie, Modularität und Flexibilität. Loopy ist ein System, das das moderne Büro bereichert.

Armonía, integración y flexibilidad. Loopy es un sistema que enriquece la oficina contemporánea.





Glider

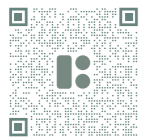

Design essenziale e personalizzazione delle finiture, così Glider rende accoglienti gli spazi di lavoro. Immersi nel bello si lavora di più e meglio.

Essential design and customization of finishes, so Glider makes workspaces welcoming. Immersed in beauty, you work more and better!

Design essentiel et personnalisation des finitions, Glider rend les espaces de travail accueillants. Immérgé dans la beauté, vous travaillez plus fort et mieux.

Minimalistisches Design und individuelle Gestaltung der Oberflächen, so macht Glider Arbeitsplätzen einladend. Eingetaucht in Schönheit, werden Sie noch gerne und besser arbeiten.

Diseño esencial y personalización de acabados, así Glider hace que los espacios de trabajo sean acogedores. Inmerso en la belleza se trabaja más y mejor.



Loopy





Office e home office. In un contesto lavorativo ibrido, gli spazi diventano flessibili e gli arredi versatili, come il sistema Glider.

Office and home office. In a hybrid working context, spaces become flexible as furnishings, like Glider system.

Bureau et homeoffice. Dans un contexte de travail hybride, les espaces deviennent flexibles, et des meubles polyvalents, comme dans le système Glider.

Büro und Homeoffice. Innerhalb einem hybriden Ambiente werden die Büro-Räume flexibel und vielseitige Einrichtungen dank an das Glider Serie.

Oficina y oficina en casa. En un contexto de trabajo híbrido, los espacios se vuelven flexibles y los muebles versátiles como el sistema Glider.





Take-Off



Glider



La versatilità dei tavoli S18 arreda con stile sale meeting e aree break.

The versatility of the S18 tables furnish meeting rooms and breakout areas, all with style.

La versatilità des tables S18 meuble avec style les salles de réunion et les espaces de repos.

Die Vielseitigkeit der S18 Serie richtet Besprechungsräume und Break-Bereiche stilvoll ein.

La versatilidad de las mesas S18 decora, con estilo, las salas de reuniones y las zonas de descanso.



Take-Off

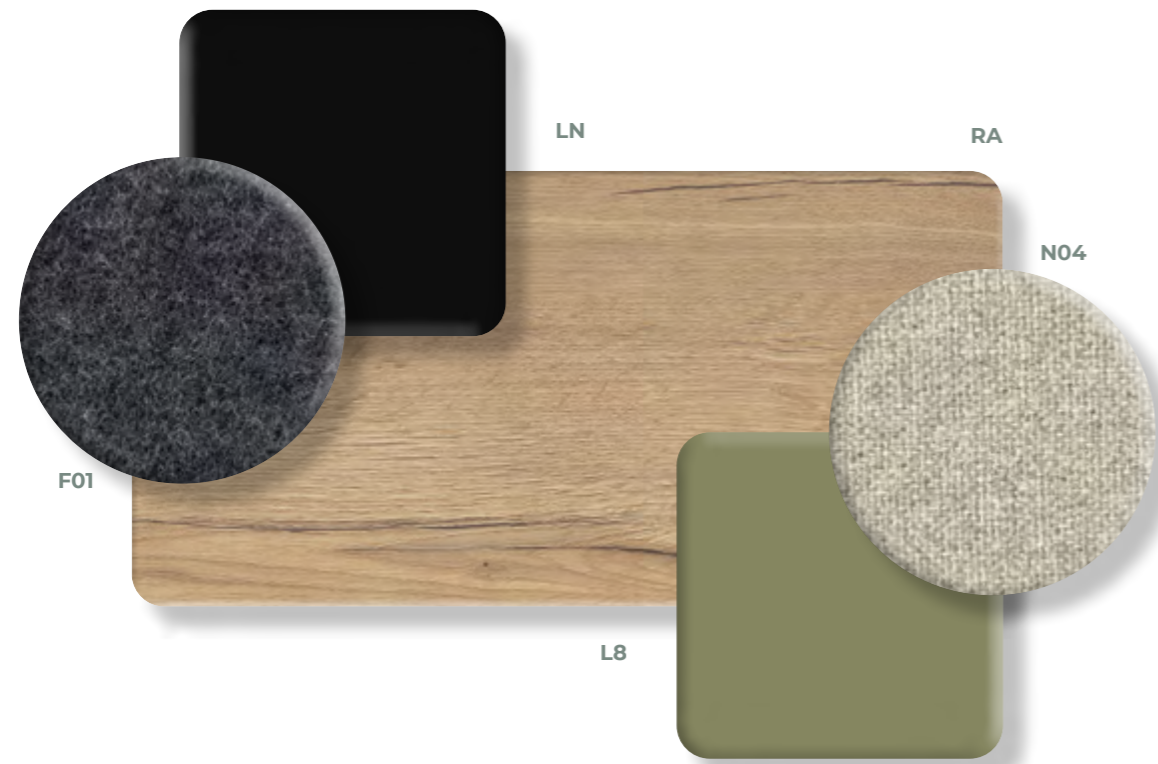
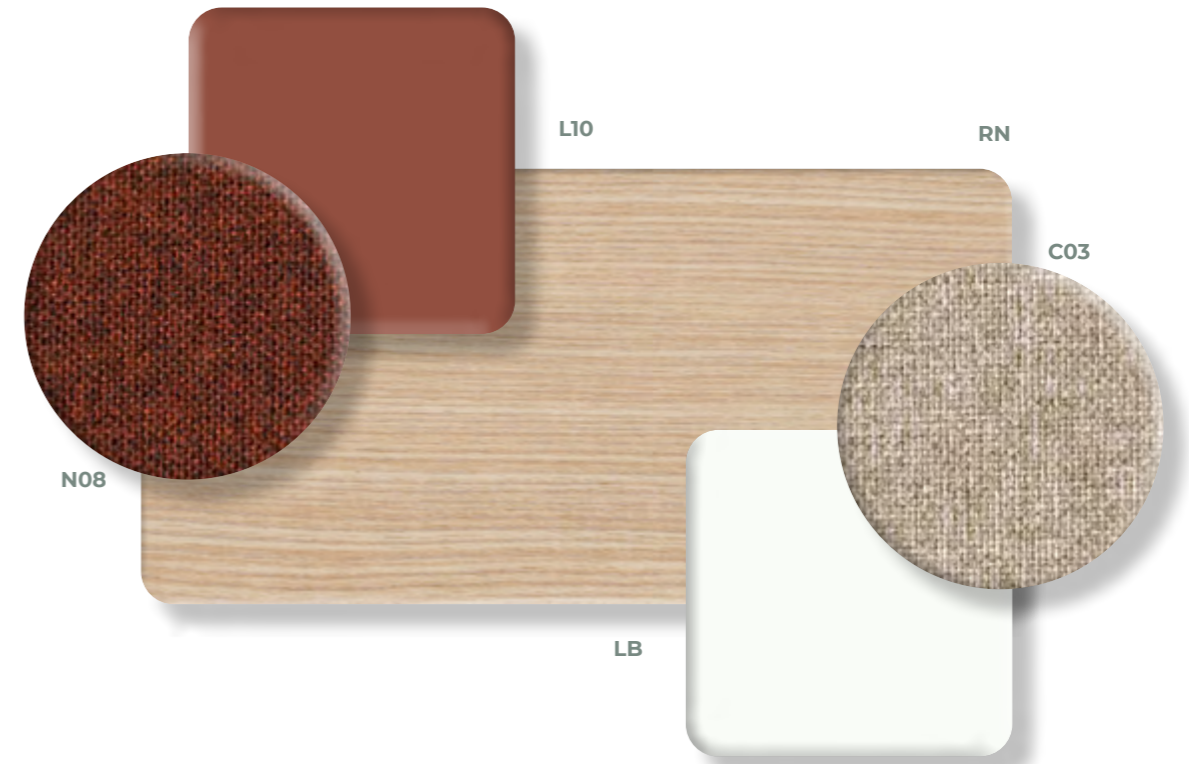
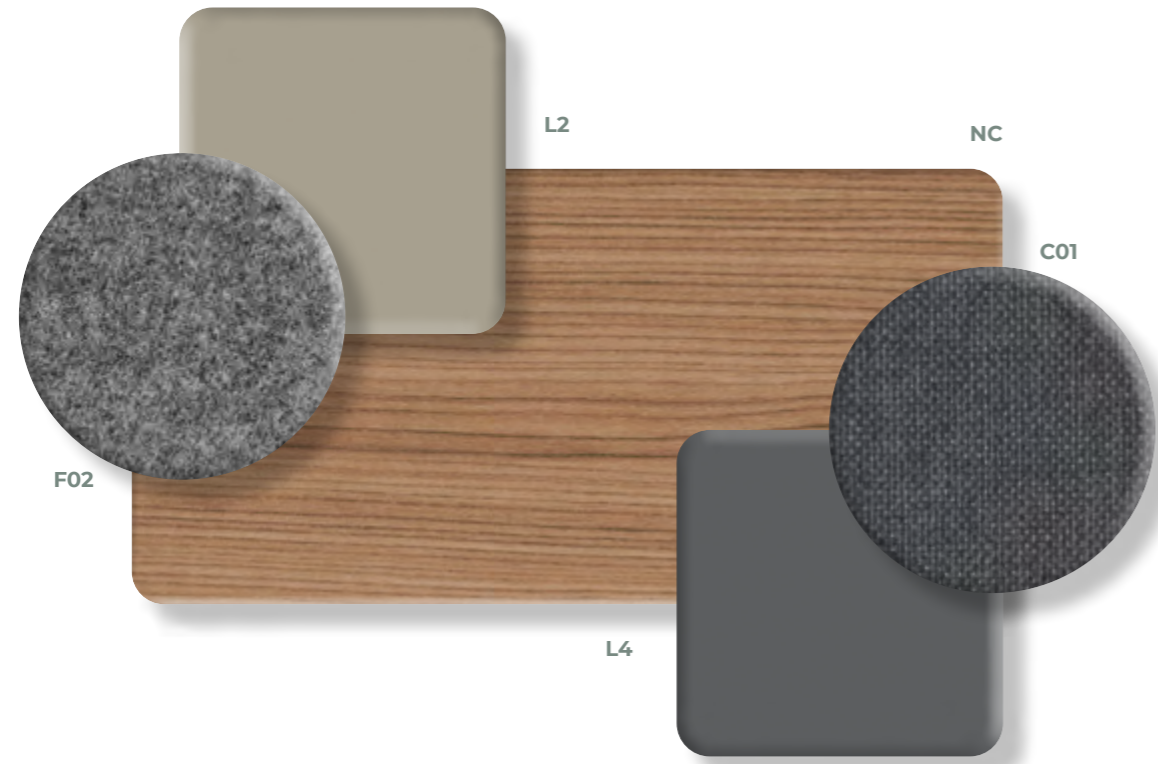



h 74 cm

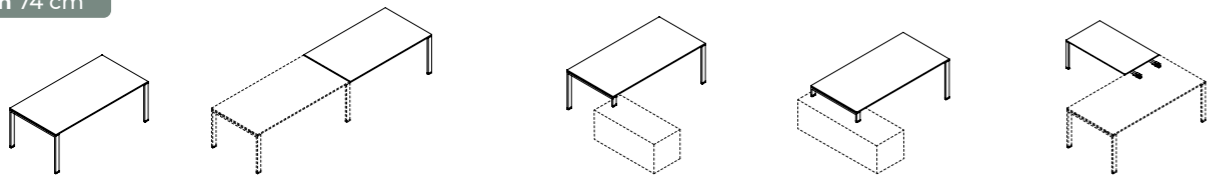

w 80÷200 cm
d 60-80 cm

w 200 cm
d 100 cm

w 160÷200 cm
d 80 cm

w 200 cm
d 100 cm

w 80-120 cm
d 60 cm

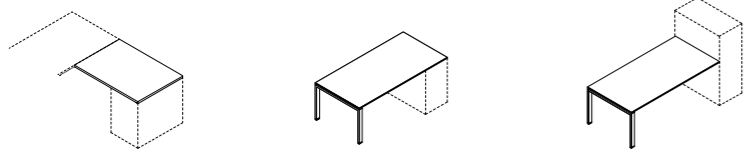

w 100-120 cm
d 60 cm

w 120-200 cm
d 60-80 cm

w 120÷200 cm
d 80 cm

h 74 cm

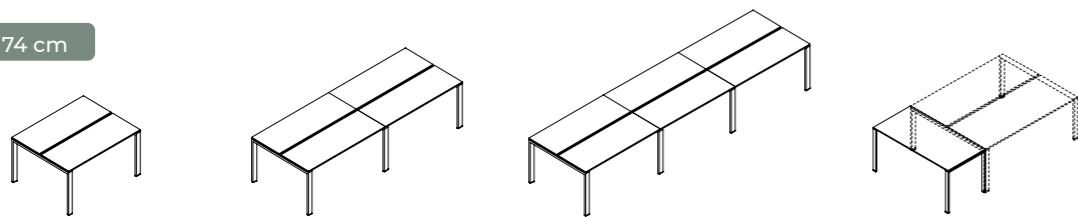

w 120÷200 cm
d 124-164 cm

w 240÷400 cm
d 124-164 cm

w 360÷600 cm
d 124-164 cm

w 124 w 164 cm
d 60 w 80 cm

h 74 cm

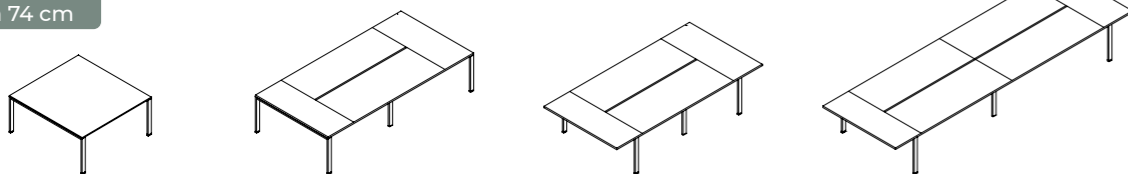

w 100÷240 cm
d 124-164 cm

w 280-320 cm
d 124-164 cm

w 240-320 cm
d 124-164 cm

w 360-520 cm
d 124-164 cm



h 38 cm

h 42 cm



∅ 110-118 cm

∅ 118 cm

∅ 118 cm

w 60-120 cm
d 60 cm

w 60-120 cm
d 60 cm

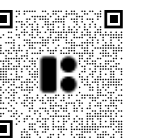
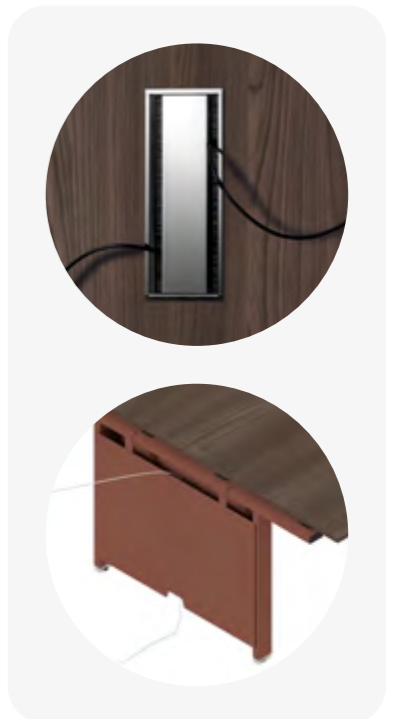
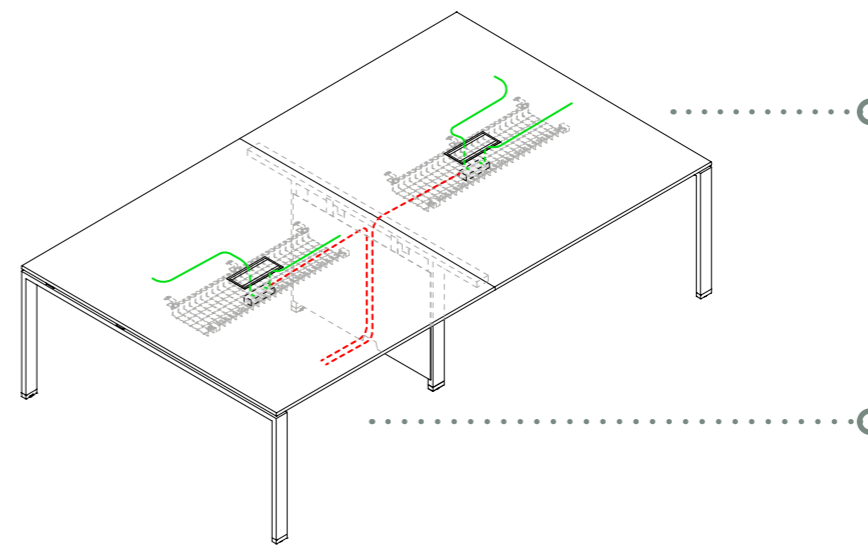
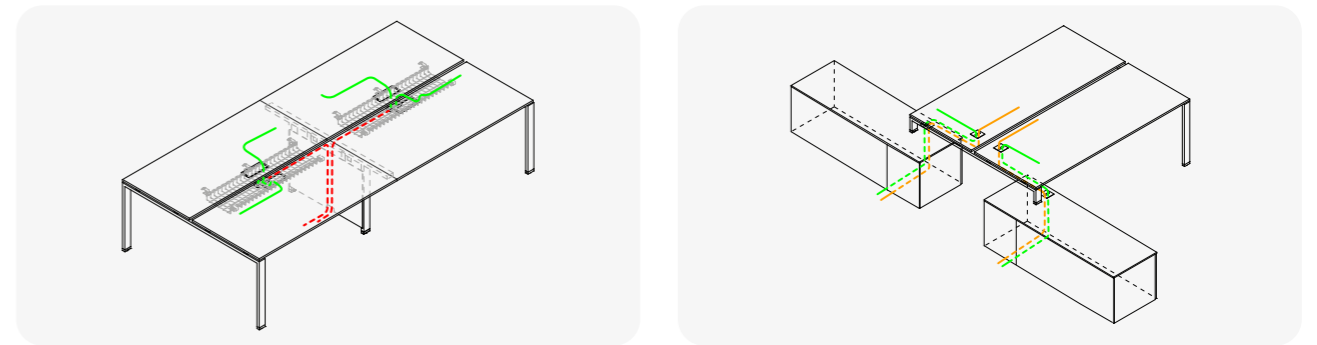
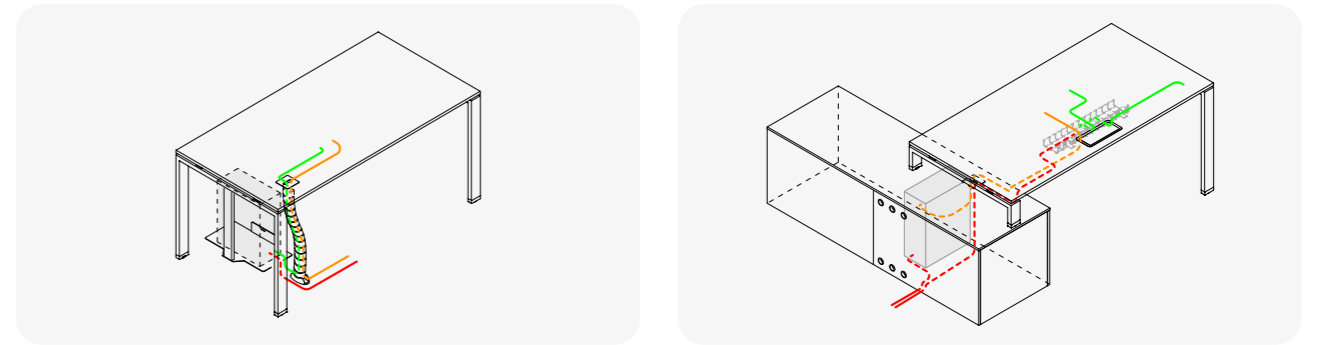



66 - 71

accessori e componenti ·

accessories and components · accessoires et composants ·
Zubehör und Komponenten · accesorios y componentes



72 - 75

accessori per elettrificazione ·

accessories for electrification · accessoires pour électrification ·
Zubehör für Elektrifizierung · accesorios para electrificación

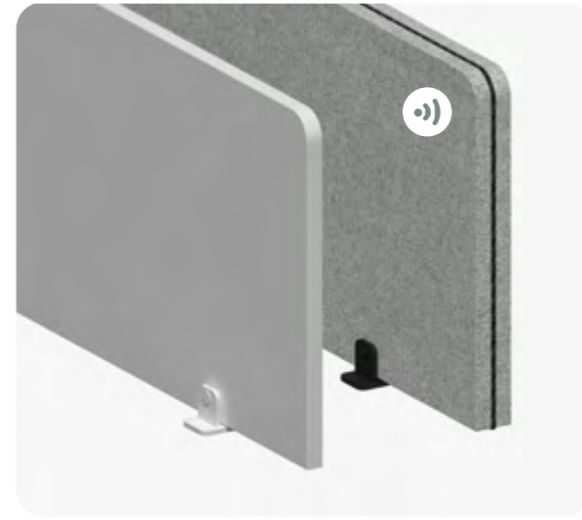

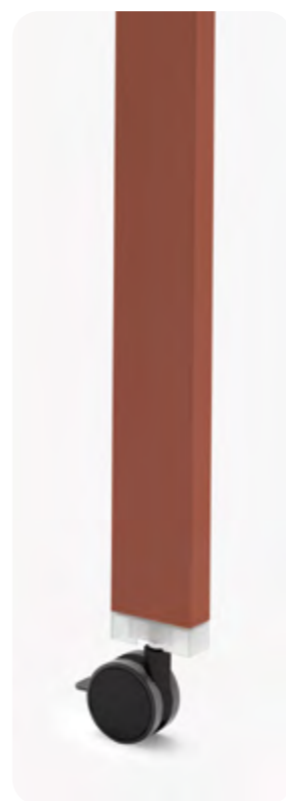

h 62 ÷ 86 cm

Regolazione in altezza ogni 2 cm
Height adjustment every 2 cm
Réglage hauteur tous les 2 cm
Höhenverstellung alle 2 cm
Ajuste de altura cada 2 cm

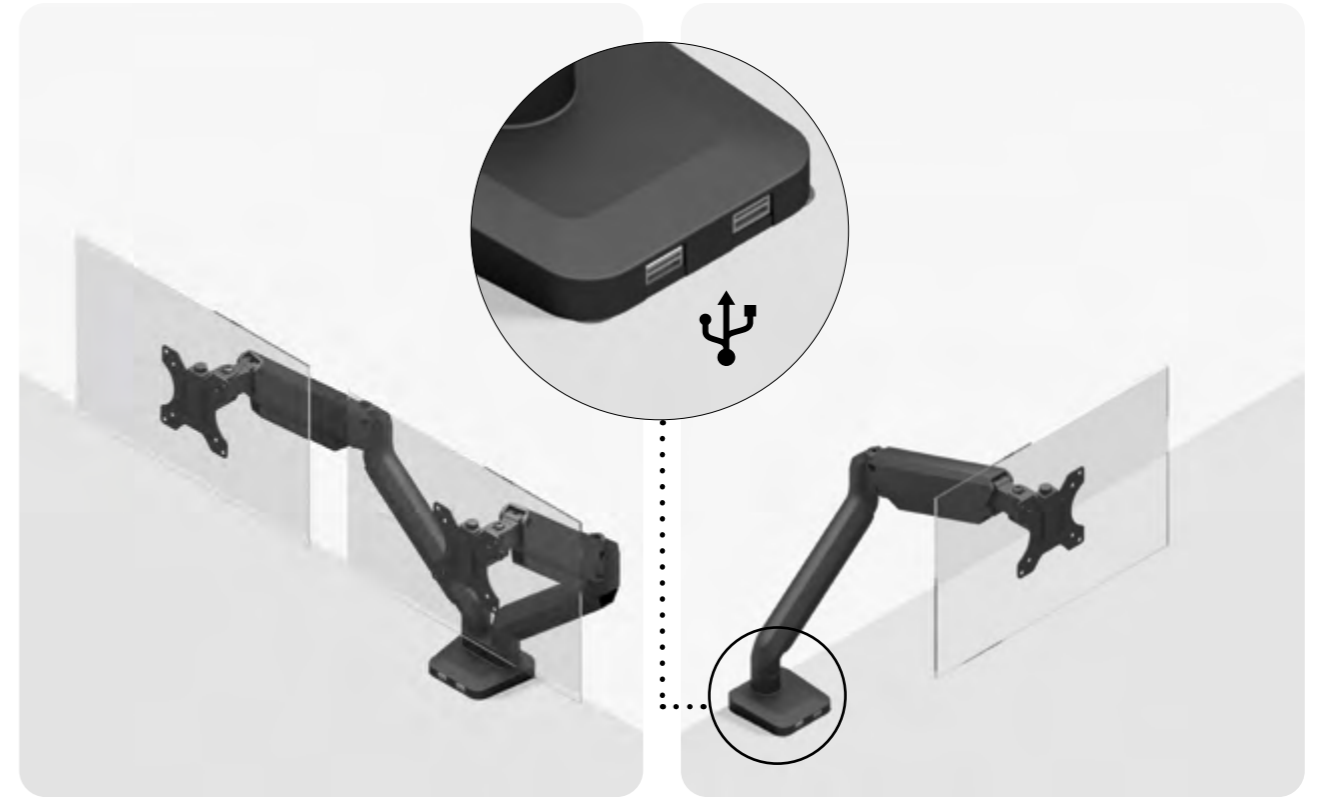



elettrificazione sopra piano, desktop electrification, électrification au-dessus du plateau,
Elektrifizierung über den Tisch, electrificación encima de la tapa



plastica, plastic, plastique,
Plastick, plástico



plastica, plastic, plastique,
Plastick, plástico
laccato opaco, lacquered matt, laqué mat
matt lackiert, lacado mate

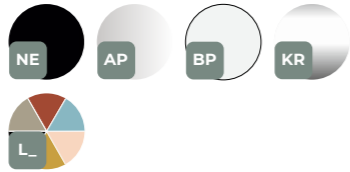

metallo, metal, métal,
metall, metal



metallo, metal, métal,
metall, metal



plastica, plastic, plastique,
Plastick, plástico



plastica, plastic, plastique,
Plastick, plástico



metallo, metal, métal,
metall, metal





elettrificazione sopra piano, desktop electrification, électrification au-dessus du plateau,
Elektrifizierung über den Tisch, electrificación encima de la tapa



plastica, plastic, plastique,
Plastick, plástico

laccato opaco, lacquered matt, laqué mat
matt lackiert, lacado mate



plastica, plastic, plastique,
Plastik, plástico



elettrificazione sotto piano, under desktop electrification, électrification sous plateau,
Elektrifizierung unter den Tisch, electrificación debajo de la tapa



cestelli portacavi, cable holder baskets, paniers porte-câbles,
Kabelwanne, bandejas portacables





melaminico • melamine • mélamine • melamin • melamina

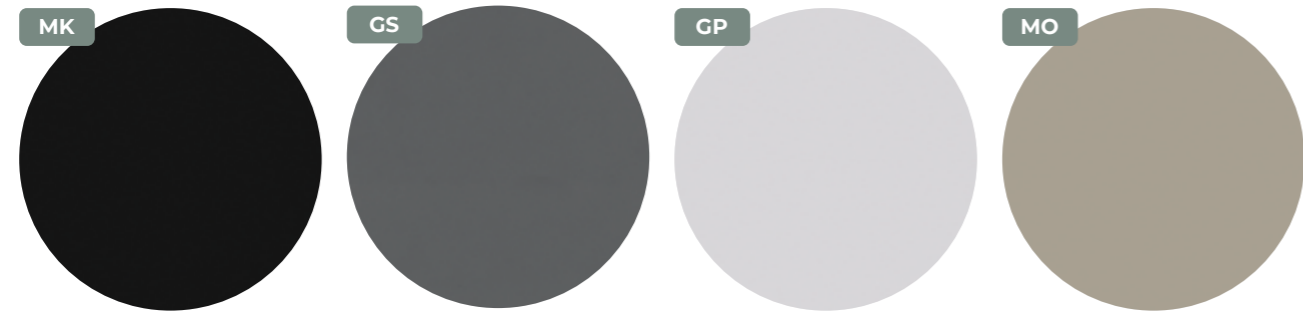

nero, black, noir, schwarz, negro

grigio granito, granite grey, gris granit, granitgrau, gris granito

grigio perla, pearl-grey, gris perle, perlgrau, gris perla

tortora, turtledove, tourterelle, taubengrau, tórtola

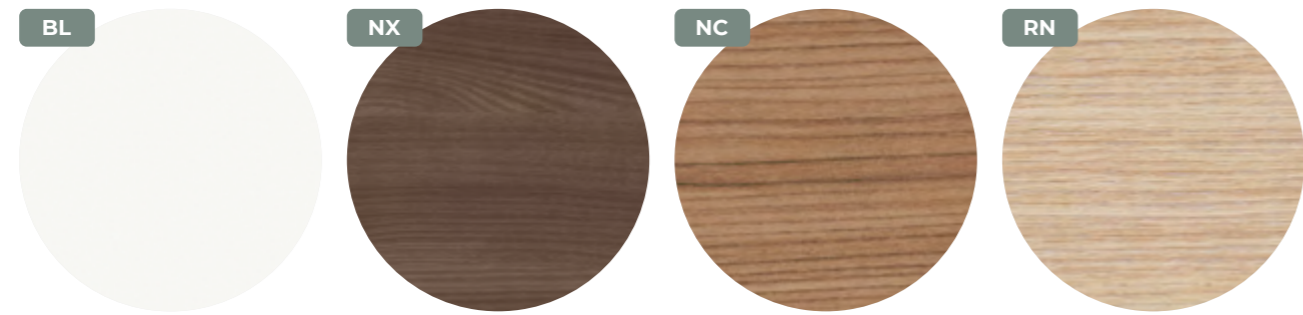

bianco, white, blanc, weiß, blanco

noce lux, walnut Lux, noyer Lux, Lux Nussbaum, nogal Lux

noce canaletto, canaletto walnut, noyer canaletto, Canaletto Nussbaum, nogal canaletto

rovere naturale, natural oak, chêne naturel, Natur Eiche, roble natural



rovere anticato, traditional oak, chêne vieilli, Eiche Antik, roble antiguo



RA - Superficie antibatterica
Antibacterial surface, surface antibactérienne,
Antibakterielle Oberfläche, superficie antibacteriana

strutture metalliche • metal structures • structures métalliques • metallgestelle • estructuras metálicas



nero
black
noir
schwarz
negro

metallo crudo
raw metal
métal brut
rohes Metall
metal bruto

grigio granito
granite grey
gris granit
granitgrau
gris granito

tortora
turtledove
tourterelle
taubengrau
tórtola

epox alluminio
silver epoxy
epoxy aluminium
epoxy aluminium
epoxidico aluminio

bianco
white
blanc
weiß
blanco

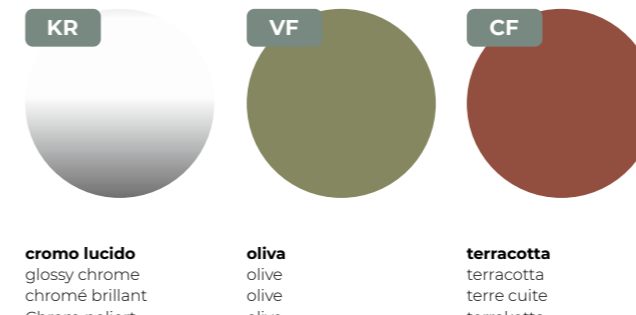

cromo lucido
glossy chrome
chromé brillant
Chrom poliert
cromo brillo

oliva
olive
olive
olive
oliva

terracotta
terracotta
terre cuite
terrakotta
terracota

laccato opaco • lacquered matt • laqué mat • matt lackiert • lacado mate

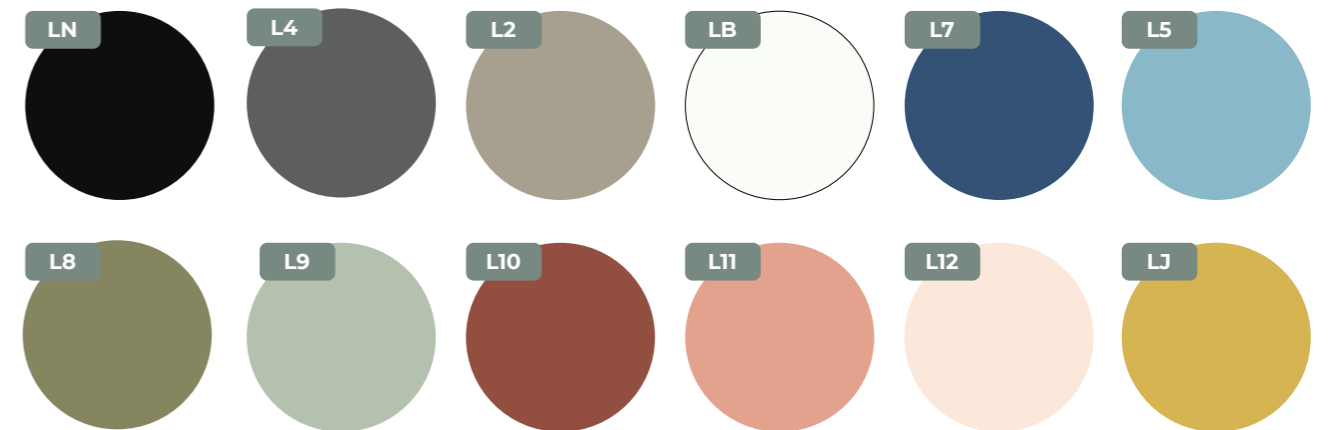

MIRAGE

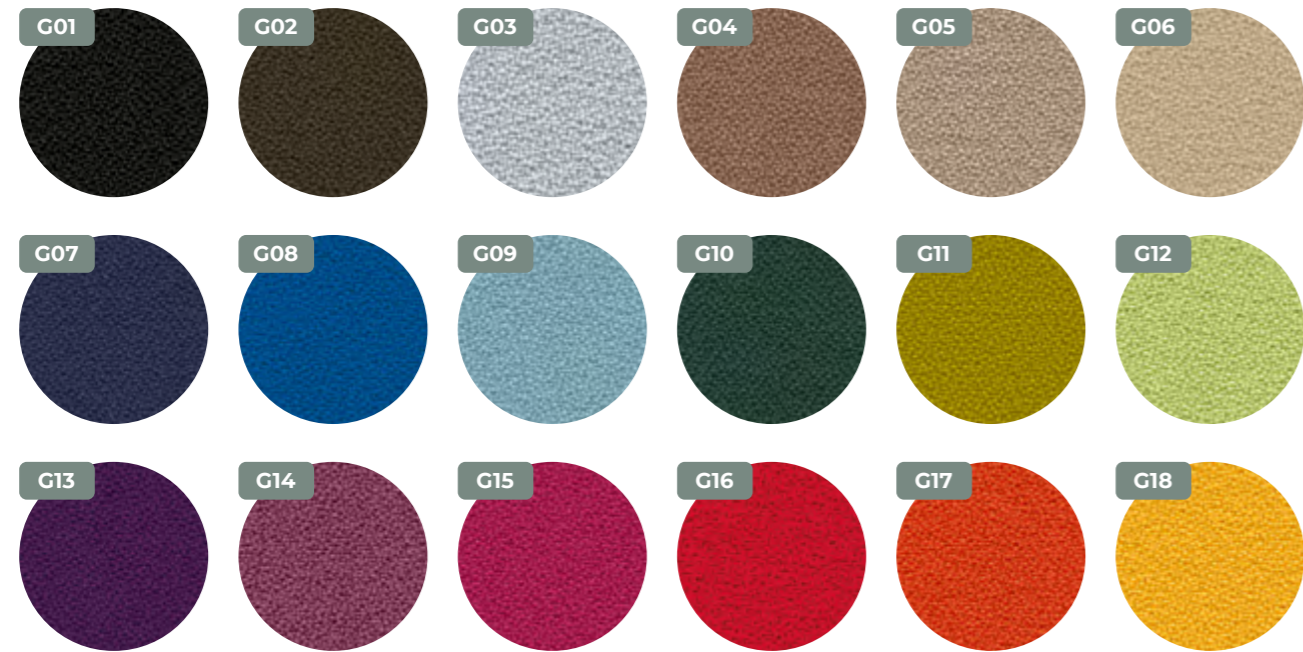

NEMI MELANGE

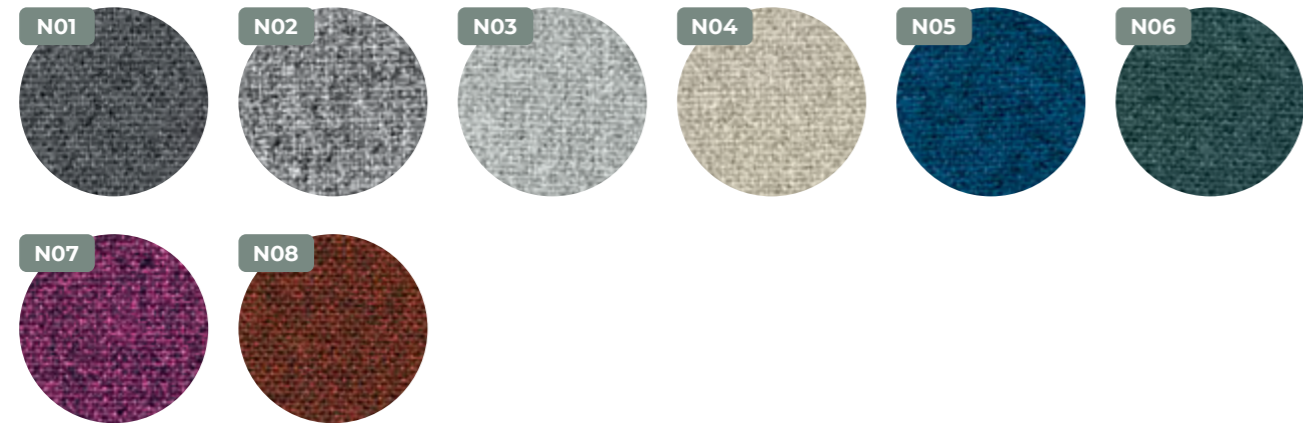

FENICE

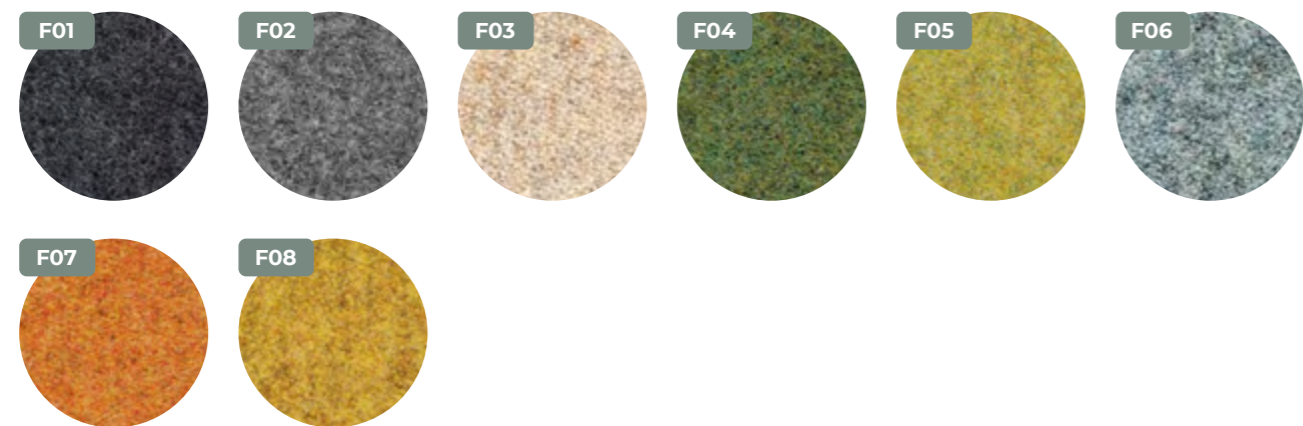

CONVERT MEL 4000

